

Panasonic®

PT Programming Manual

Pure IP-PBX

Model No. **KX-NCP500/KX-NCP1000**
KX-TDE100/KX-TDE200/KX-TDE600



Thank you for purchasing a Panasonic Pure IP-PBX.
Please read this manual carefully before using this product and save this manual for future use.

KX-NCP500/KX-NCP1000: PBMPR Software File Version 7.0000 or later
KX-TDE100/KX-TDE200: PMMPR Software File Version 7.0000 or later
KX-TDE600: PGMPR Software File Version 7.0000 or later

Document Version: 2013-05

Introduction

About this Programming Manual

The PT Programming Manual is designed to serve as a reference to programming the Panasonic Pure IP-PBX using a Panasonic proprietary telephone (PT) with display.

The PT Programming Manual is divided into the following sections:

Section 1, Overview

Provides an overview of programming the PBX.

Section 2, PT Programming

Serves as reference operating instructions when using a display PT to program the PBX.

Section 3, Appendix

Provides a list of all related PT programming items for each feature as Feature Programming References.

References Found in the PT Programming Manual

PT Programming Manual References

Related sections of the PT Programming Manual are listed for your reference.

Feature Manual References

The Feature Manual explains what the PBX can do, as well as how to obtain the most of its many features and facilities. Sections from the Feature Manual are listed throughout the PT Programming Manual for your reference.

Links to Other Pages and Manuals

If you are viewing this manual with a PC, certain items are linked to different sections of the PT Programming Manual and other Pure IP-PBX manuals. Click on a link to jump to that section.

Linked items include:

- [PT Programming Manual References](#)
- [Feature Manual References](#)

Safety Notices

Please observe the safety notices in this manual in order to avoid danger to users or other people, and prevent damage to property.

The notices are classified as follows, according to the severity of injury or damage:



This notice means that misuse could result in death or serious injury.



This notice means that misuse could result in injury or damage to property.

WARNING

Unplug the PBX from the AC outlet if it emits smoke, an abnormal smell or makes unusual noise. These conditions can cause fire or electric shock. Confirm that smoke has stopped and contact an authorized Panasonic Factory Service Center.

NOTES

- The contents of this manual apply to PBXs with a certain software version, as indicated on the cover of this manual. To confirm the software version of your PBX, see **[190] Main Processing (MPR) Software Version Reference**.
- Some optional hardware, software, and features are not available in some areas, or for some PBX models. Please consult your certified Panasonic dealer for more information.
- Product specifications are subject to change without notice.
- For details about PT programming using the KX-NT400, refer to the Operating Instructions for the KX-NT400.
- In this manual, KX-NT500 series mean KX-NT543, KX-NT546 and KX-NT560.

Table of Contents

1	Overview	9
1.1	Introduction	10
1.1.1	Introduction	10
1.1.2	Password Security	10
1.1.3	Entering Characters	11
2	PT Programming	13
2.1	PT Programming	14
2.1.1	Programming Instructions	14
2.1.2	Slot Number and Port Number	16
2.1.3	Basic Programming	17
	[000] Date & Time	17
	[001] System Speed Dialing Number	17
	[002] System Speed Dialing Name	17
	[003] Extension Number	17
	[004] Extension Name	17
	[005] Extension Personal Identification Number (PIN)	18
	[006] Operator Assignment	18
	[007] DSS Console Paired Telephone	18
	[008] Absent Message	18
2.1.4	System Management Programming	19
	[100] Flexible Numbering	19
	[101] Time Service Switching Mode	19
	[102] Time Service Starting Time	19
	[103] Idle Line Access (Local Access)	19
	[110] System Password for Administrator—for PT Programming	20
	[111] System Password for User—for PT Programming	20
	[112] Manager Password	20
	[120] Verification Code	20
	[121] Verification Code Name	20
	[122] Verification Code Personal Identification Number (PIN)	20
	[123] Verification Code COS Number	21
	[190] Main Processing (MPR) Software Version Reference	21
2.1.5	Timer Programming	21
	[200] Hold Recall Time	21
	[201] Transfer Recall Time	21
	[203] Intercept Time	21
	[204] Hot Line Waiting Time	21
	[205] Automatic Redial Repeat Times	22
	[207] Door Unlock Time	22
	[208] Call Duration Count Starting Time for LCOT	22
	[209] DISA Delayed Answer Time	22
	[210] DISA CO-to-CO Line Call Prolong Time	22
	[211] DISA Intercept Time	22
2.1.6	TRS/ARS Programming	23
	[300] TRS Override by System Speed Dialing	23
	[301] TRS Denied Code	23
	[302] TRS Exception Code	23
	[303] Special Carrier Access Code	23
	[304] Emergency Number	23
	[320] ARS Mode	24
	[321] ARS Leading Number	24

	[322] ARS Routing Plan Table Number	24
	[325] ARS Exception Number	24
	[330] ARS Routing Plan Time Table	24
	[331–346] ARS Routing Plan Table (1–16) (KX-NCP500/KX-NCP1000/KX-TDE100/ KX-TDE200 only)	25
	[347] ARS Routing Plan Table (1–48)	25
	[350] ARS Carrier Name	25
	[351] ARS Trunk Group for Carrier Access	25
	[352] ARS Removed Number of Digits for Carrier Access	26
	[353] ARS Carrier Access Code	26
2.1.7	CO Line Programming	26
	[400] LCOT CO Line Connection	26
	[401] LCOT CO Line Name	26
	[402] LCOT Trunk Group Number	26
	[409] LCOT CO Line Number Reference	27
	[410] LCOT Dialing Mode	27
	[411] LCOT Pulse Rate	27
	[412] LCOT DTMF Minimum Duration	27
	[413] LCOT CPC Signal Detection Time—Outgoing	27
	[414] LCOT CPC Signal Detection Time—Incoming	27
	[416] LCOT Pause Time	28
	[417] LCOT Flash/Recall Time	28
	[418] LCOT Disconnect Time	28
	[450] DIL 1:1 Destination	28
	[451] DID Number	28
	[452] DID Name	28
	[453] DID Destination	29
	[471] Host PBX Access Code	29
	[472] Extension-to-CO Line Call Duration	29
	[473] CO-to-CO Line Call Duration	29
	[475] DISA Silence Detection	29
	[476] DISA Continuous Signal Detection	30
	[477] DISA Cyclic Signal Detection	30
	[490] Caller ID Signal Type	30
2.1.8	COS Programming	30
	[500] Trunk Group Number	30
	[501] TRS Level	31
	[502] CO Line Call Duration Limitation	31
	[503] Call Transfer to CO Line	31
	[504] Call Forwarding to CO Line	31
	[505] Executive Busy Override	31
	[506] Executive Busy Override Deny	31
	[507] DND Override	31
	[508] Account Code Mode	32
	[509] TRS Level for System Speed Dialing	32
	[510] TRS Level for Extension Dial Lock	32
	[511] Manager Assignment	32
	[512] Permission for Door Open Access	32
	[514] Time Service Manual Switching	32
	[515] Wireless XDP Parallel Mode for Paired Telephone	32
	[516] Programming Mode Limitation	33
2.1.9	Extension Programming	33
	[600] EXtra Device Port (XDP) Mode	33
	[601] Terminal Device Assignment	33
	[602] Class of Service	33

	[603] Extension User Group	34
	[604] Extension Intercept Destination	34
	[605] Call Forwarding—No Answer Time	34
	[606] CLIP Number	34
	[620] Incoming Call Distribution Group Member	34
	[621] Incoming Call Distribution Group Delayed Ringing	35
	[622] Incoming Call Distribution Group Floating Extension Number	35
	[623] Incoming Call Distribution Group Name	35
	[624] Incoming Call Distribution Group Distribution Method	35
	[625] Destination for Overflow Time Expiration	35
	[626] Overflow Time	36
	[627] Destination When All Busy	36
	[628] Queuing Call Capacity	36
	[629] Queuing Hurry-up Level	36
	[630] Queuing Time Table	36
	[631] Sequences in Queuing Time Table	37
	[632] Maximum Number of Agents	37
	[640] Extension User Groups of a Paging Group	37
	[641] External Pagers of a Paging Group	37
	[650] Extension User Groups of a Pickup Group	38
	[660] VM Group Floating Extension Number	38
	[680] Idle Extension Hunting Type	38
	[681] Idle Extension Hunting Group Member	38
	[690] PS Registration	39
	[691] PS Termination	39
	[692] Personal Identification Number (PIN) for PS Registration	39
	[699] CS Status Reference	39
2.1.10	Resource/Interface Programming	40
	[700] External Pager Floating Extension Number	40
	[710] Music Source Selection for BGM (for KX-NCP500/KX-NCP1000)/BGM2 (for KX-TDE100/KX-TDE200/KX-TDE600)	40
	[711] Music on Hold	40
	[712] Music for Transfer	40
	[720] Doorphone Call Destination	41
	[729] Doorphone Number Reference	41
	[730] Outgoing Message (OGM) Floating Extension Number	41
	[731] Outgoing Message (OGM) Name	41
	[732] DISA Security Mode	41
2.1.11	SMDR & Maintenance Programming	41
	[800] RS-232C Parameter—New Line Code	41
	[800] RS-232C Parameter—Baud Rate	42
	[800] RS-232C Parameter—Word Length	42
	[800] RS-232C Parameter—Parity Bit	42
	[800] RS-232C Parameter—Stop Bit Length	42
	[801] External Modem Control	42
	[802] SMDR Page Length	42
	[803] SMDR Skip Perforation	42
	[804] SMDR Outgoing Call Printing	43
	[805] SMDR Incoming Call Printing	43
	[810] Remote Programming	43
	[811] Modem Floating Extension Number	43
	[812] ISDN Remote Floating Extension Number	43
2.1.12	Card Programming	43
	[900] Slot Card Type Reference	43
	[901] Slot Card Deletion	44

[902] Slot Card Reset	44
[910] OPB3 Option Card Type Reference	44
[911] OPB3 Option Card Deletion	44
3 Appendix	45
3.1 Revision History	46
3.1.1 KX-NCP500/KX-NCP1000 PBMPR Software File Version 2.02xx	46
3.1.2 KX-NCP500/KX-NCP1000 PBMPR Software File Version 6.0xxx	46
3.1.3 KX-NCP500/KX-NCP1000 PBMPR Software File Version 7.xxxx	46
3.1.4 KX-TDE100/KX-TDE200 PMMPR Software File Version 3.0xxx	46
3.1.5 KX-TDE100/KX-TDE200 PMMPR Software File Version 6.0xxx	47
3.1.6 KX-TDE100/KX-TDE200 PMMPR Software File Version 7.xxxx	47
3.1.7 KX-TDE600 PGMPR Software File Version 3.0xxx	47
3.1.8 KX-TDE600 PGMPR Software File Version 6.0xxx	47
3.1.9 KX-TDE600 PGMPR Software File Version 7.xxxx	48
3.2 Feature Programming References	49

Section 1

Overview

This section provides an overview of programming the PBX.

1.1 Introduction

1.1.1 Introduction

These programming instructions are designed to serve as an overall system programming reference for the Panasonic Pure IP-PBX. Each feature in the PBX has default settings that can be changed to customize the PBX to your requirements. These settings control the functions of the PBX, and changing them is referred to as "system programming".

Only one person can perform system programming at a time. Any other users trying to enter system programming mode will be denied access.

Ways to Program

There are two programming methods:

- **PC (Personal Computer) Programming**
All features and settings of the PBX can be programmed through PC programming with Maintenance Console. Installing and starting Maintenance Console are explained in the Installation Manual.
- **PT (Proprietary Telephone) Programming**
A subset of the features and settings of the PBX can be programmed using a PT. PT programming is described in Section 2.1 PT Programming. An extension user can perform system programming by entering three-digit programming numbers with a PT.

1.1.2 Password Security

To maintain system security, system passwords are required to access certain programming functions of the PBX. By giving different users access to different passwords, it is possible to control the amount of programming that each user is able to perform.

The following types of system passwords are available:

Password	Description	Format
System Password (PT) for User	Used to access user-level PT programming. The specific PT programming items that may be programmed at user level can be selected through system programming.	4–10 digits
System Password (PT) for Administrator	Used to access administrator-level PT programming. All PT programming settings are available.	

CAUTION

To the Administrator or Installer regarding the system password

1. Please provide all system passwords to the customer.
2. To avoid unauthorized access and possible abuse of the PBX, keep the passwords secret, and inform the customer of the importance of the passwords, and the possible dangers if they become known to others.
3. The PBX has default passwords preset. For security, change these passwords the first time that you program the PBX.
4. Change the passwords periodically.
5. It is strongly recommended that passwords of 10 numbers or characters be used for maximum protection against unauthorized access. For a list of numbers and characters that can be used in system passwords, refer to Section 1.1.3 Entering Characters.

6. If a system password is forgotten, it can be found by loading a backup of the system data into a PC, and checking the password using the Maintenance Console software. If you do not have a backup of the system data, you must reset the PBX to its factory defaults and reprogram it. Therefore, we strongly recommend maintaining a backup of the system data. For more information on how to back up the system data, refer to the on-line help of the Maintenance Console. However, as system passwords can be extracted from backup copies of the system data file, do not allow unauthorized access to these files.

1.1.3 Entering Characters

The following characters can be used when storing a name, message, or other text entry data using a PT. The tables below show you the characters available by pushing each button a specific number of times.

Table 1 (Standard mode)

Times Buttons	1	2	3	4	5	6	7	8	9
1	!	?	"	1					
2	A	B	C	a	b	c	2		
3	D	E	F	d	e	f	3		
4	G	H	I	g	h	i	4		
5	J	K	L	j	k	l	5		
6	M	N	O	m	n	o	6		
7	P	Q	R	S	p	q	r	s	7
8	T	U	V	t	u	v	8		
9	W	X	Y	Z	w	x	y	z	9
0	(space)	.	,	'	:	;	0		
*	/	+	-	=	<	>	*		
#	\$	%	&	@	()	€	£	#

Table 2 (Option mode)



Times Buttons	1	2	3	4	5	6	7	8	9	10	11	12	13	14	15
1	!	?	"	ä	ö	ü	1								
2	À	B	C	a	b	c	À	Á	Â	Ã	Ä	Å	Æ	Ç	2
3	D	E	F	d	e	f	Ð	È	É	Ê	Ë	3			
4	G	H	I	g	h	i	ì	í	î	ï	4				
5	J	K	L	j	k	l	5								
6	M	N	O	m	n	o	Ñ	Ò	Ó	Ô	Õ	Ö	Ø	Œ	6
7	P	Q	R	S	p	q	r	s	Š	ß	7				
8	T	U	V	t	u	v	Û	Ú	Û	Ü	8				
9	W	X	Y	Z	w	x	y	z	Ý	Ž	9				
0	(space)	.	,	'	:	;	0								
*	/	+	-	=	<	>	*								
#	\$	%	&	@	()	€	£	#						

[Example of Entering Characters]

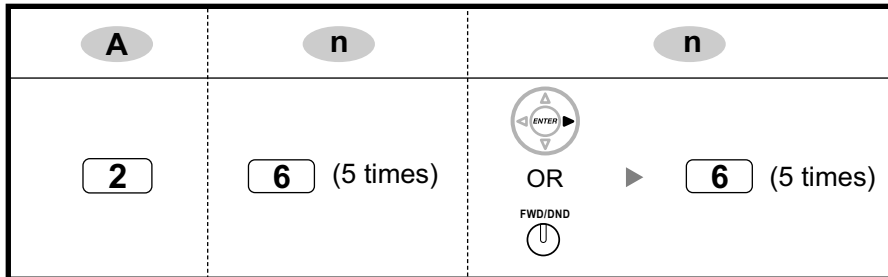
To enter "Ann":



Note

- To erase the character on the cursor, press CLEAR.
- To move the cursor to the left, press .
- To move the cursor to the right, press . When entering two or more characters that use the same button consecutively (e.g., "G" and "I"), you must press this button or the FWD/DND button after entering the first character.
- If SELECT is pressed, the characters for each button will be displayed in reverse order.
- To toggle between Table 1 and Table 2 when using the KX-NT300/KX-NT500/KX-DT300/KX-T7600 series, press the leftmost soft button.

Section 2

PT Programming

This section serves as reference operating instructions when using a display PT to program the PBX.

2.1 PT Programming

2.1.1 Programming Instructions









Required Telephone/Extension

PBX settings can be customized through system programming by using a multi-line display Digital Proprietary Telephone (DPT) or IP Proprietary Telephone (IP-PT), such as the KX-NT343, KX-NT346 or KX-NT500 series. Multi-line display Analogue Proprietary Telephones (APTs) are not supported. To access system programming, the Class of Service (COS) assigned to the PT's extension must be programmed to allow system programming, or the PT must be connected to the lowest-numbered port on the card installed in the lowest-numbered slot. Only one system programming session can be performed at a time. This means that only one user can access system programming at a time, whether through a PT or PC.

For a list of characters that can be entered during system programming, see Section 1.1.3 Entering Characters.

Buttons and Functions

Fixed Buttons			Function
KX-NT300/KX-NT500/ KX-DT300	KX-NT136/KX-T7600	KX-T7200/KX-T7400 ^{*1}	
			PREVIOUS
			NEXT
			(Page up)
			(Page down)
			ENTER
		—	Back to Previous Menu (CANCEL)
			SHIFT
			PROGRAM
			END
			SELECT

Fixed Buttons			Function
KX-NT300/KX-NT500/ KX-DT300	KX-NT136/KX-T7600	KX-T7200/KX-T7400 ^{*1}	
			FLASH
			CLEAR
			SECRET

*1 The buttons shown in this column are from the KX-T7400 series.

Entering System Programming Mode

Using a PT to perform system programming allows an authorized extension user to set a wide range of PBX features and parameters.

There are two levels of system programming that can be performed with a PT: administrator-level programming and user-level programming.

Administrator Level:

Allows the programming of all settings accessible through PT programming.

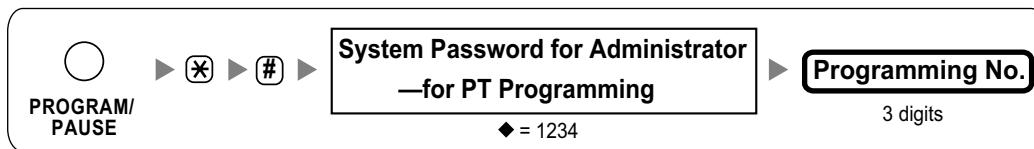

User Level:

Allows the programming of limited settings as permitted through PC programming.

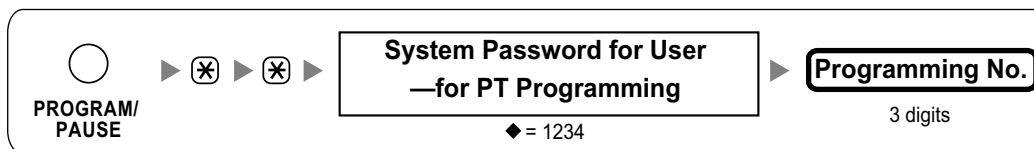

Note

◆ means default value throughout this manual.

Programming Structure

Programming Number	Programming Group Title	Description
[0XX]	Basic Programming	Frequently used programming steps
[1XX]	System Management Programming	Global system parameters
[2XX]	Timer Programming	System timers

Programming Number	Programming Group Title	Description
[3XX]	TRS/ARS Programming	TRS and Automatic Route Selection (ARS) programming
[4XX]	CO Line Programming	CO line and trunk group settings
[5XX]	COS Programming	Class of Service parameters
[6XX]	Extension Programming	Extension feature settings
[7XX]	Resource/Interface Programming	PBX interface and external device settings
[8XX]	SMDR & Maintenance Programming	Station Message Detail Recording (SMDR) and maintenance feature settings
[9XX]	Card Programming	Used to display the cards currently installed in the PBX, or to delete a card from system programming before physically removing it.

2.1.2 Slot Number and Port Number

Some programming items require a slot number and port number to be entered, as in the example below.



Slot numbers and port numbers are entered as two-digit numbers (e.g., "04" for slot 4). However, for KX-TDE600, slot numbers are entered as three-digit numbers of the form "XYY":

- X: Shelf number (1–4)
- YY: Slot number (01–11)

PBX Model	Free Slot Number
KX-NCP500	01–05
KX-NCP1000	01–07
KX-TDE100	01–06
KX-TDE200	01–11
KX-TDE600	101–110
	201–211
	301–311
	401–411

2.1.3 Basic Programming

[000] Date & Time

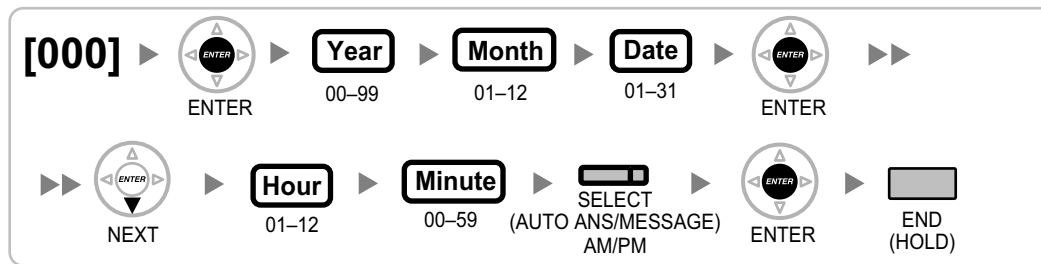

[001] System Speed Dialing Number

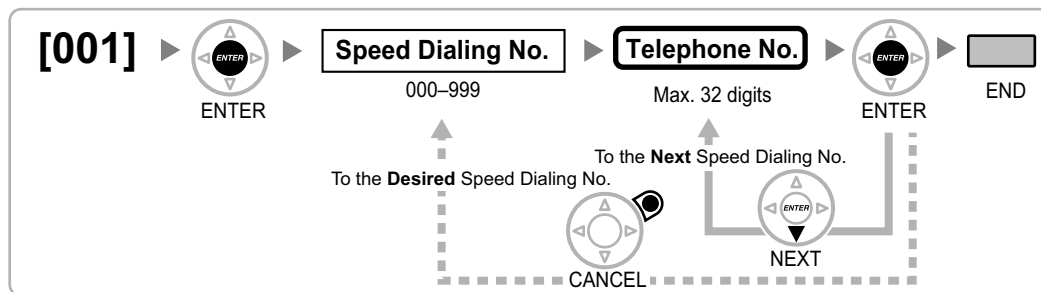

[002] System Speed Dialing Name

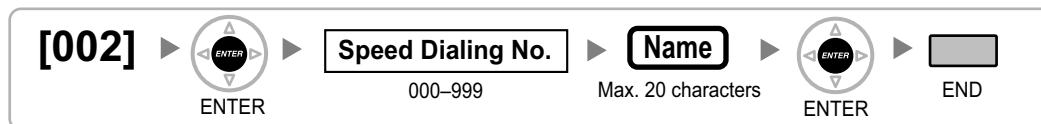

[003] Extension Number

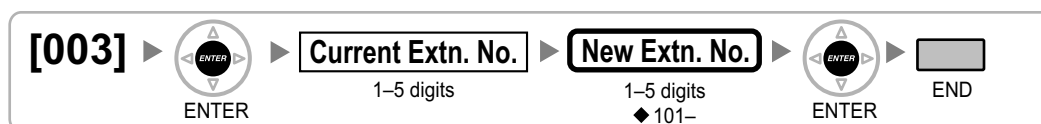

Note

If PC Phone, PC Console, or a CTI application is running on a PC connected to an extension whose extension number is to be programmed/modified, quit the application first.

[004] Extension Name



[005] Extension Personal Identification Number (PIN)**CAUTION**

There is a risk that fraudulent telephone calls will be made if a third party discovers a personal identification number (PIN) (verification code PIN or extension PIN) of the PBX.

The cost of such calls will be billed to the owner/renter of the PBX.

To protect the PBX from this kind of fraudulent use, we strongly recommend:

- a. Keeping PINs secret.
- b. Selecting complex, random PINs that cannot be easily guessed.
- c. Changing PINs frequently.

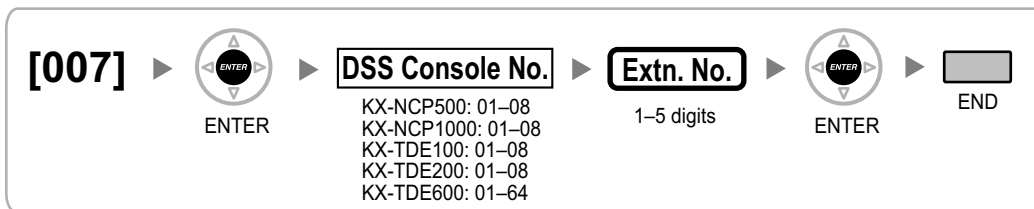
[006] Operator Assignment**[007] DSS Console Paired Telephone****Note**

This program is only available after the port connected to the DSS Console is assigned as "DSS Console" in [601] Terminal Device Assignment.

Note that if one or more SDN buttons have been set at the DSS Console, they must be deleted before this setting can be changed.

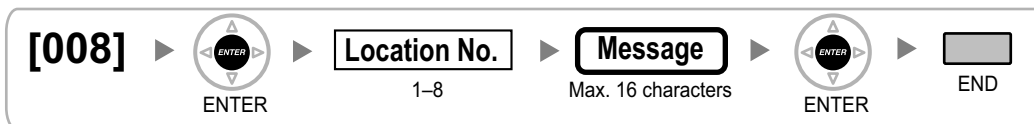
[008] Absent Message

◆ For default values, see "1.1.1 Absent Message" in the Feature Manual.

2.1.4 System Management Programming

[100] Flexible Numbering

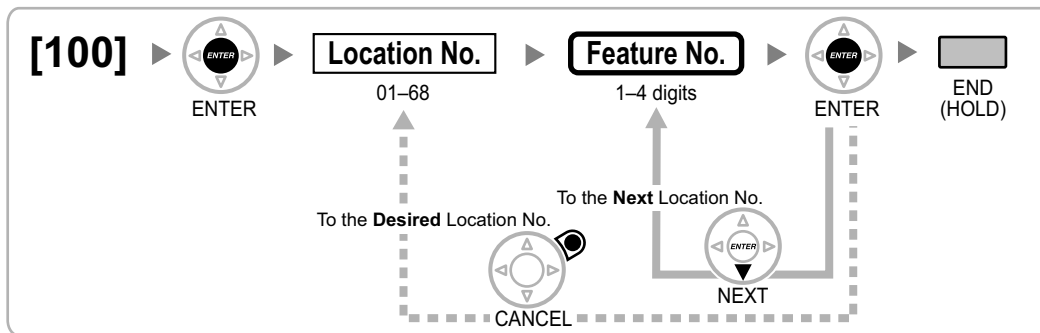

◆ For default values, see "6.1.4 Flexible Numbering/Fixed Numbering" in the Feature Manual.

[101] Time Service Switching Mode

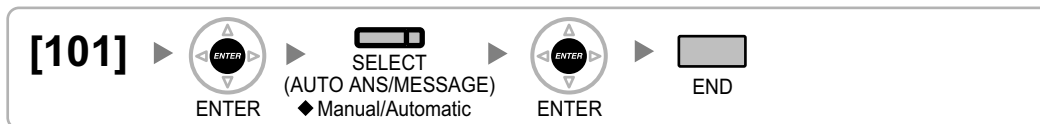

[102] Time Service Starting Time

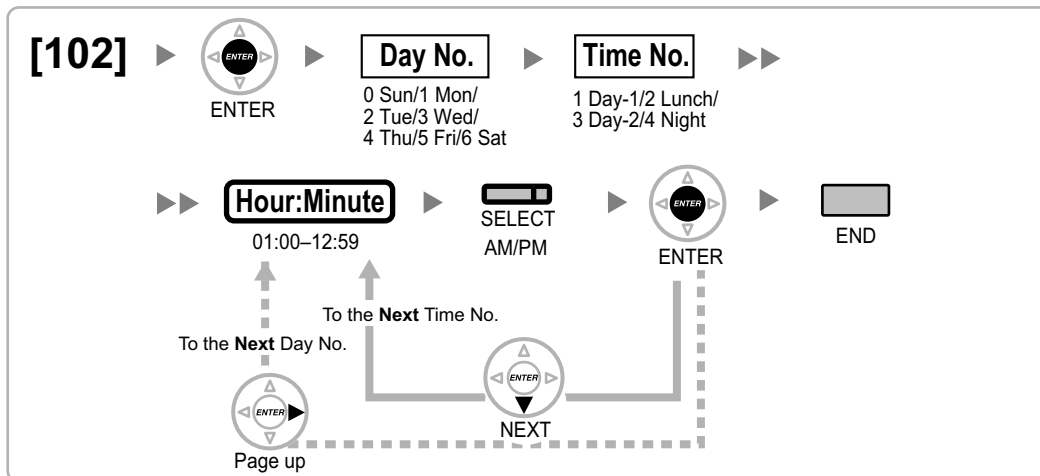

[103] Idle Line Access (Local Access)

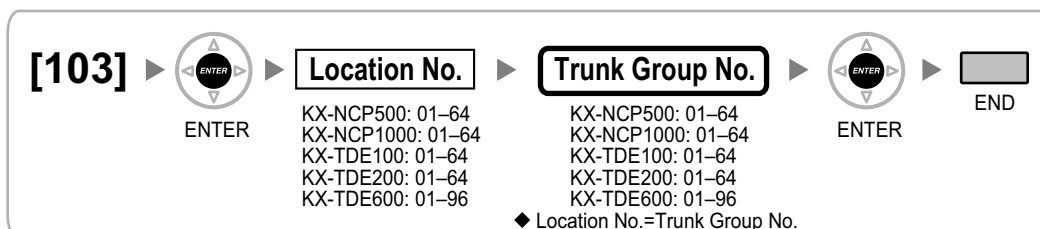

[110] System Password for Administrator—for PT Programming

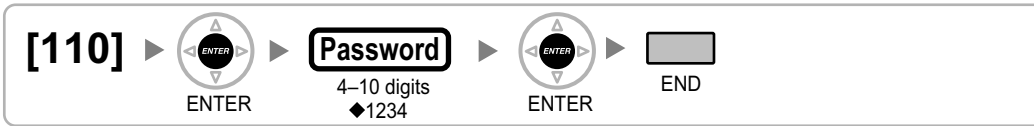

[111] System Password for User—for PT Programming



[112] Manager Password



[120] Verification Code

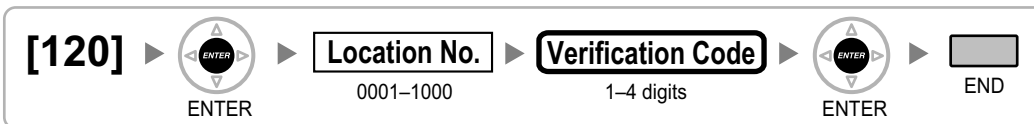

[121] Verification Code Name



[122] Verification Code Personal Identification Number (PIN)



CAUTION

There is a risk that fraudulent telephone calls will be made if a third party discovers a personal identification number (PIN) (verification code PIN or extension PIN) of the PBX.

The cost of such calls will be billed to the owner/renter of the PBX.

To protect the PBX from this kind of fraudulent use, we strongly recommend:

- a. Keeping PINs secret.
- b. Selecting complex, random PINs that cannot be easily guessed.

c. Changing PINs frequently.

[123] Verification Code COS Number

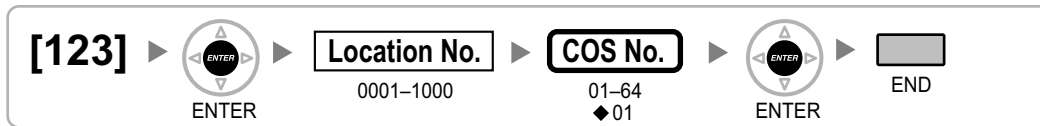

[190] Main Processing (MPR) Software Version Reference



2.1.5 Timer Programming

[200] Hold Recall Time



[201] Transfer Recall Time



[203] Intercept Time



[204] Hot Line Waiting Time



[205] Automatic Redial Repeat Times



[207] Door Unlock Time



[208] Call Duration Count Starting Time for LCOT



[209] DISA Delayed Answer Time



[210] DISA CO-to-CO Line Call Prolong Time



[211] DISA Intercept Time

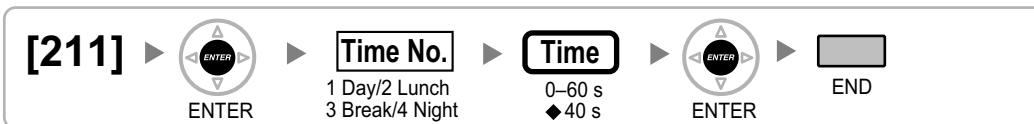

2.1.6 TRS/ARS Programming

[300] TRS Override by System Speed Dialing

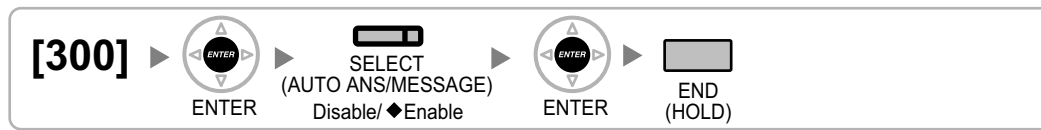

[301] TRS Denied Code

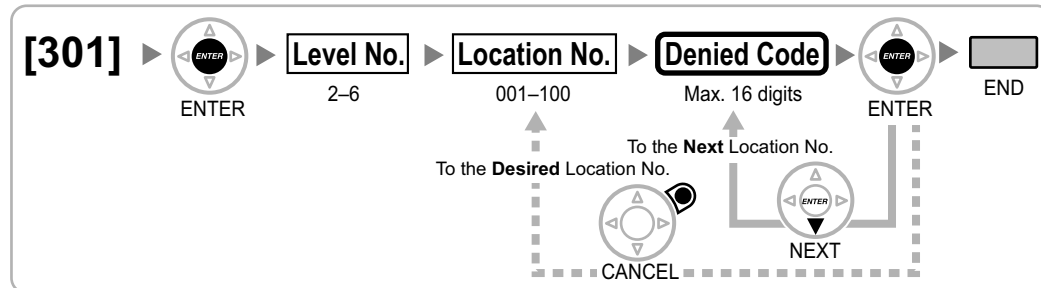

[302] TRS Exception Code

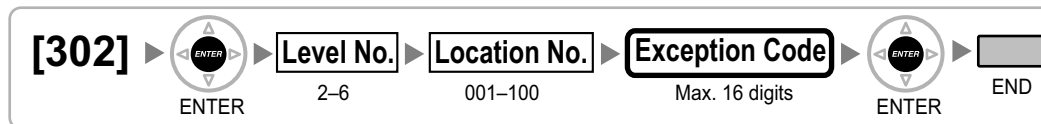

[303] Special Carrier Access Code

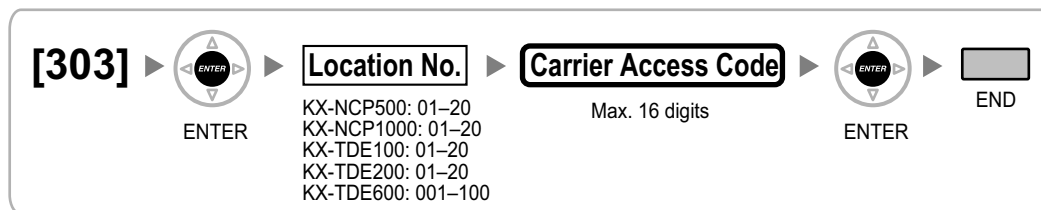

[304] Emergency Number



[320] ARS Mode



[321] ARS Leading Number

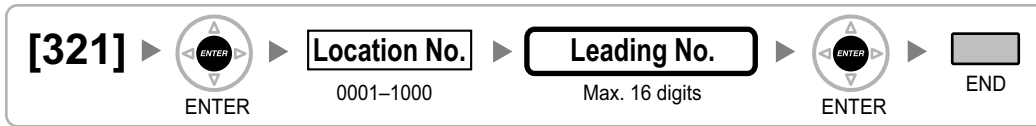

[322] ARS Routing Plan Table Number

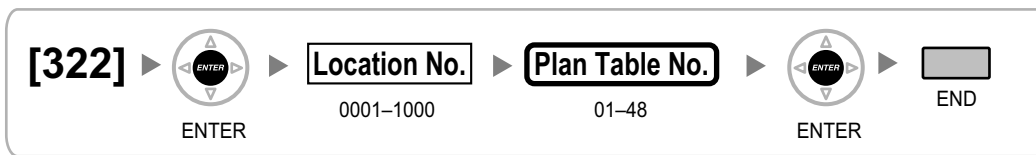

[325] ARS Exception Number



[330] ARS Routing Plan Time Table

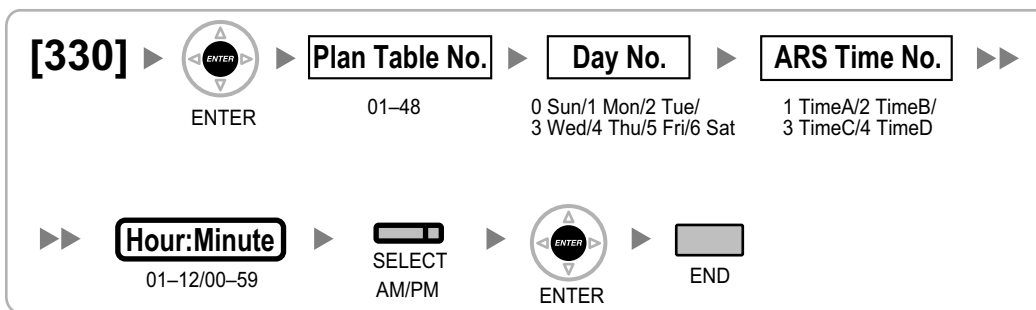

[331–346] ARS Routing Plan Table (1–16) (KX-NCP500/KX-NCP1000/ KX-TDE100/KX-TDE200 only)

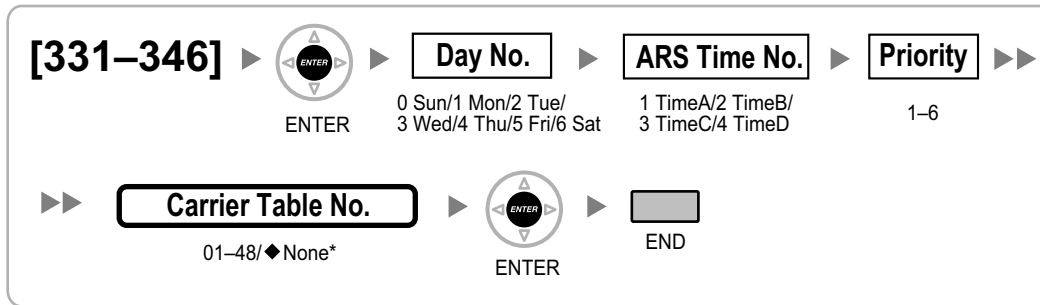

* For programs [331] to [340], when Priority 1 is selected, the default value of Carrier Table No. is as follows:
 [331]: 01, [332]: 02, [333]: 03, [334]: 04, [335]: 05,
 [336]: 06, [337]: 07, [338]: 08, [339]: 09, [340]: 10

[347] ARS Routing Plan Table (1–48)

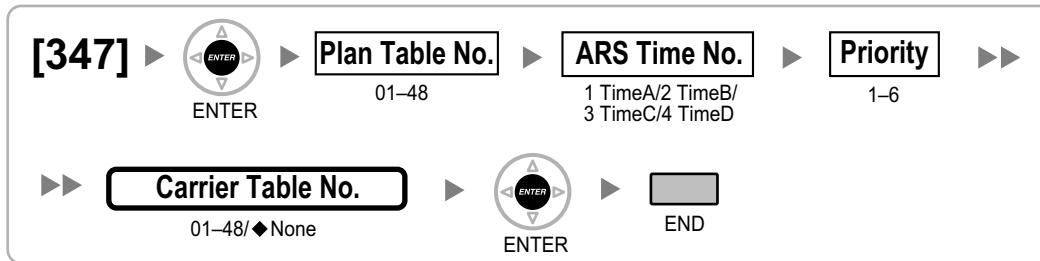

[350] ARS Carrier Name



[351] ARS Trunk Group for Carrier Access

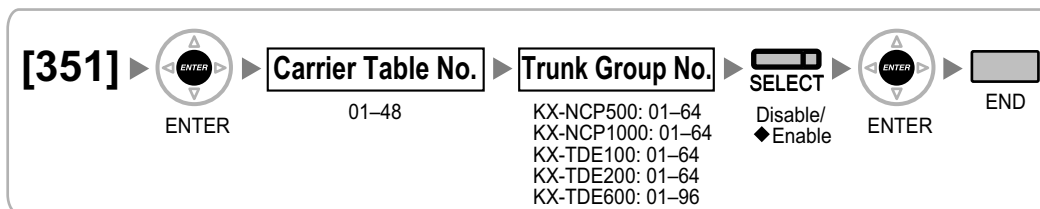

[352] ARS Removed Number of Digits for Carrier Access

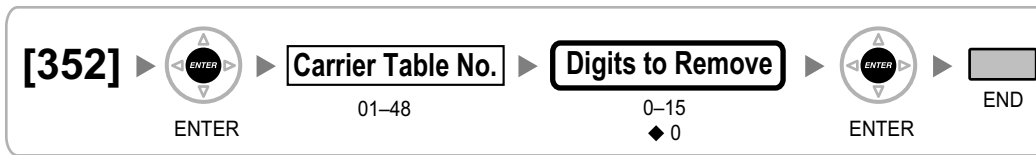

[353] ARS Carrier Access Code

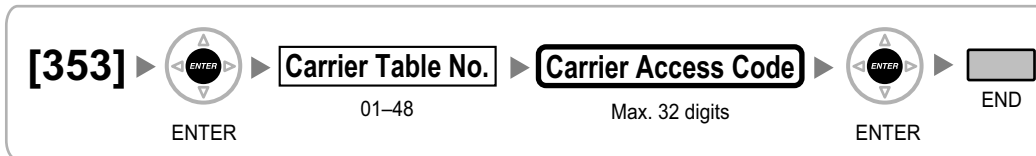

2.1.7 CO Line Programming

[400] LCOT CO Line Connection

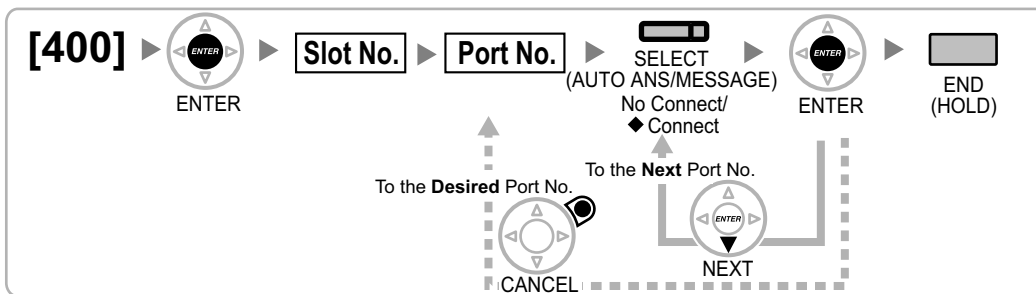

[401] LCOT CO Line Name



[402] LCOT Trunk Group Number

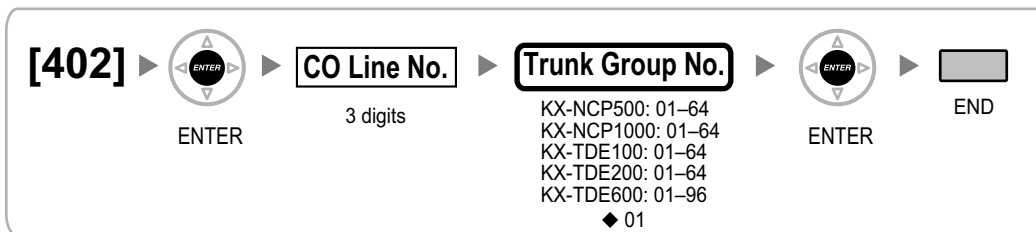

[409] LCOT CO Line Number Reference**[410] LCOT Dialing Mode****[411] LCOT Pulse Rate****[412] LCOT DTMF Minimum Duration****[413] LCOT CPC Signal Detection Time—Outgoing****[414] LCOT CPC Signal Detection Time—Incoming**

[416] LCOT Pause Time



[417] LCOT Flash/Recall Time



[418] LCOT Disconnect Time



[450] DIL 1:1 Destination

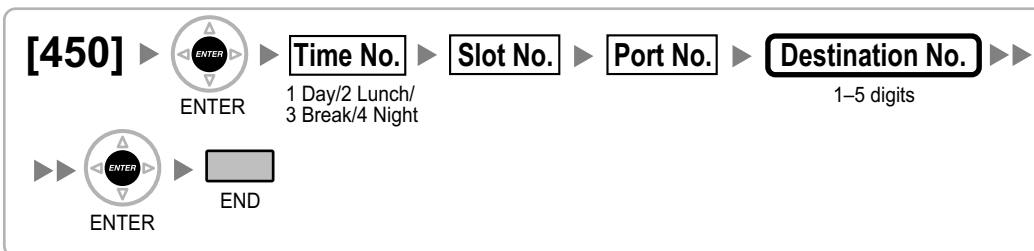

[451] DID Number



[452] DID Name



[453] DID Destination

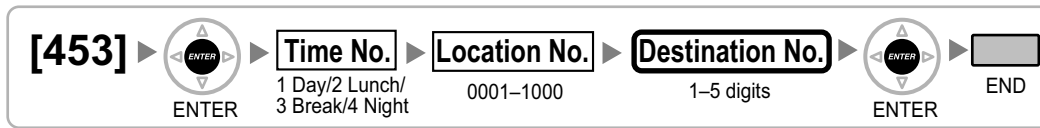

[471] Host PBX Access Code

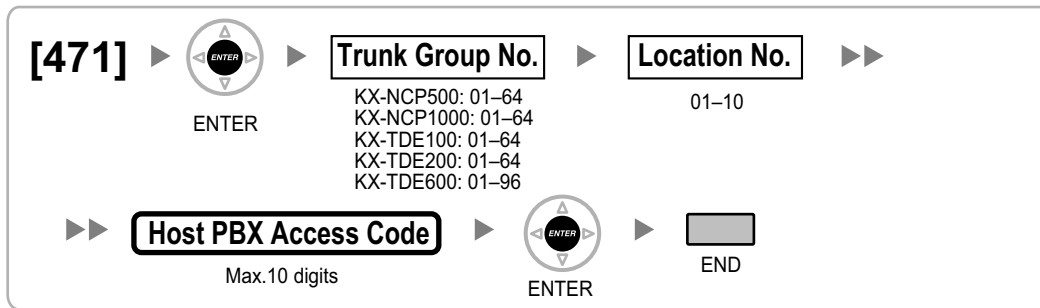

[472] Extension-to-CO Line Call Duration

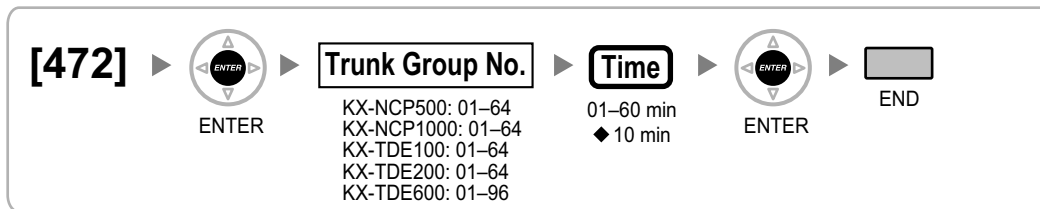

[473] CO-to-CO Line Call Duration

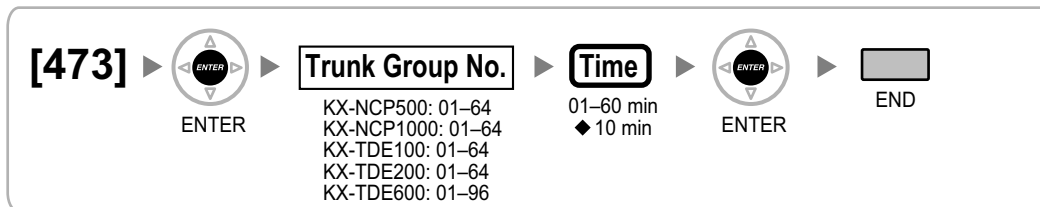

[475] DISA Silence Detection

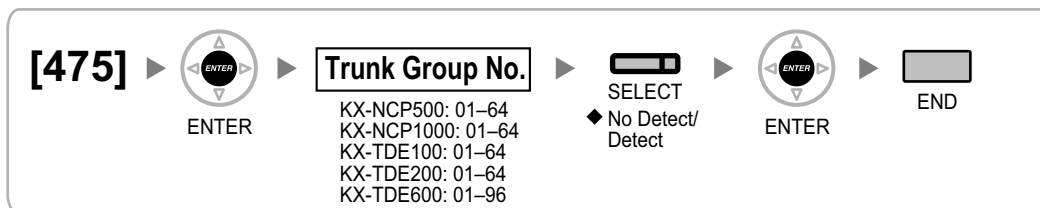

[476] DISA Continuous Signal Detection

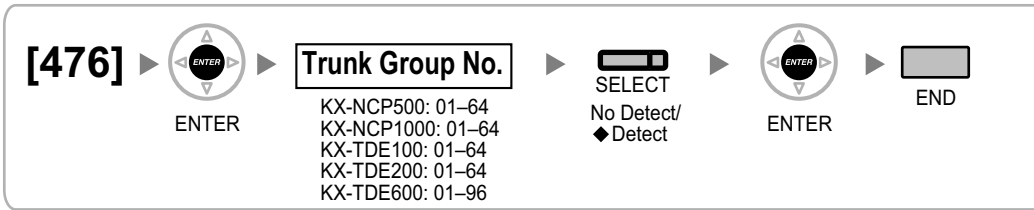

[477] DISA Cyclic Signal Detection

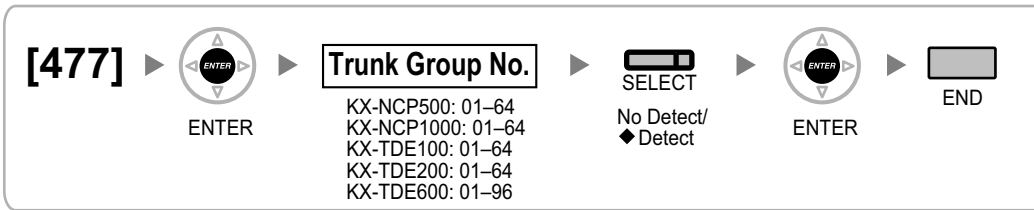

[490] Caller ID Signal Type



2.1.8 COS Programming

[500] Trunk Group Number

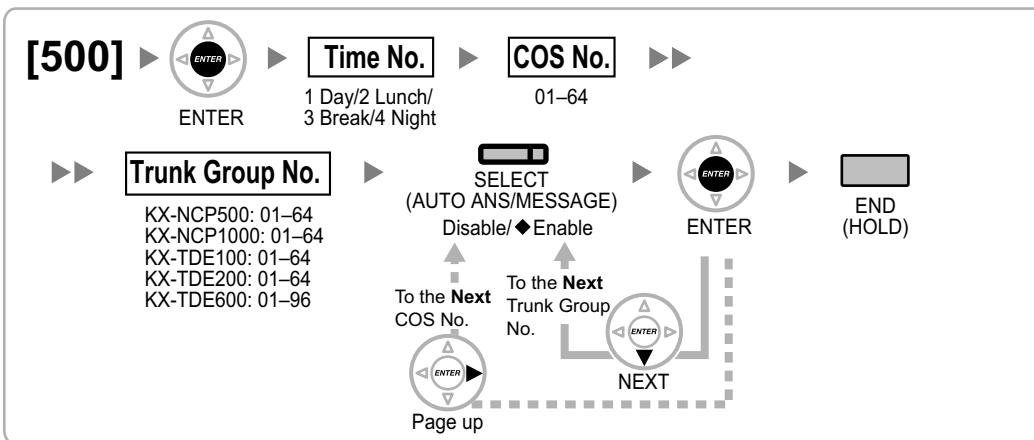

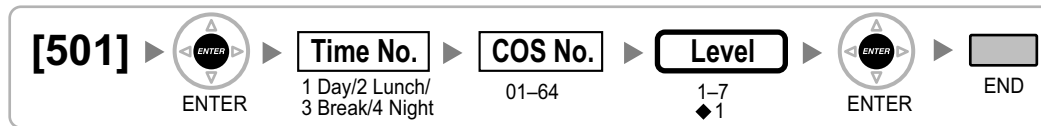
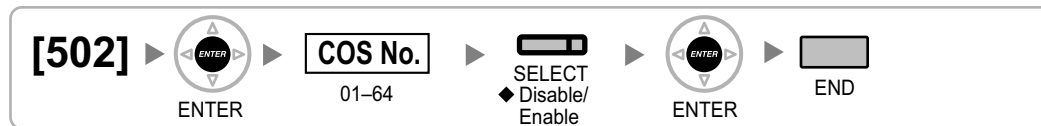
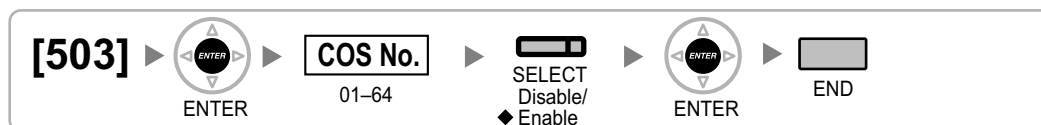
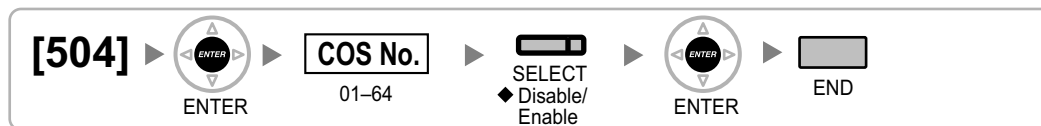
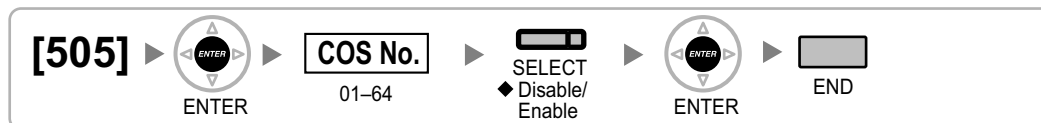
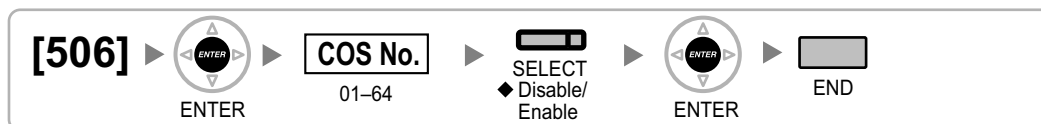
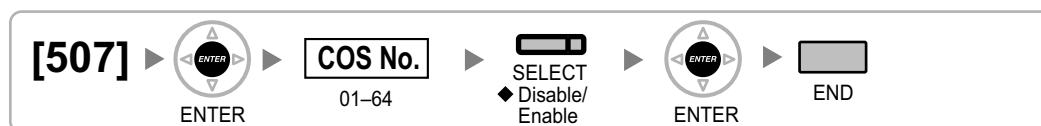
[501] TRS Level**[502] CO Line Call Duration Limitation****[503] Call Transfer to CO Line****[504] Call Forwarding to CO Line****[505] Executive Busy Override****[506] Executive Busy Override Deny****[507] DND Override**

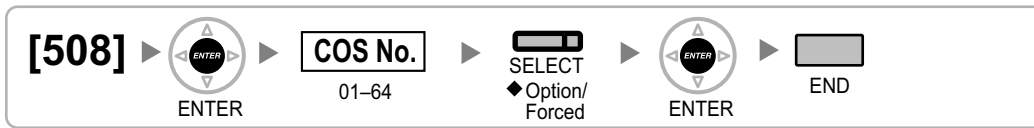
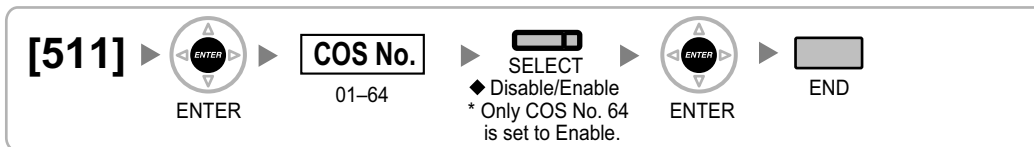
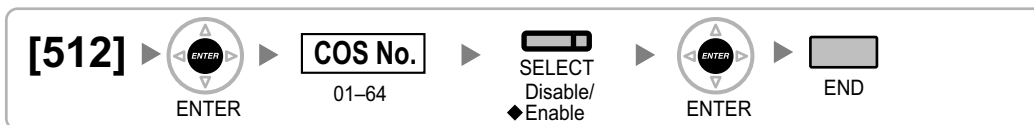
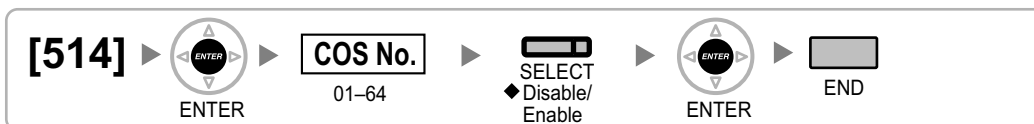
[508] Account Code Mode**[509] TRS Level for System Speed Dialing****[510] TRS Level for Extension Dial Lock****[511] Manager Assignment****[512] Permission for Door Open Access****[514] Time Service Manual Switching****[515] Wireless XDP Parallel Mode for Paired Telephone**

[516] Programming Mode Limitation

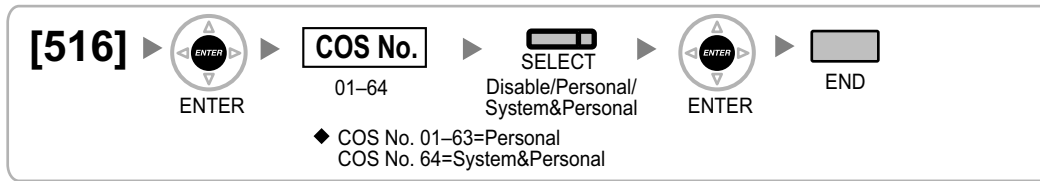

2.1.9 Extension Programming

[600] EXtra Device Port (XDP) Mode

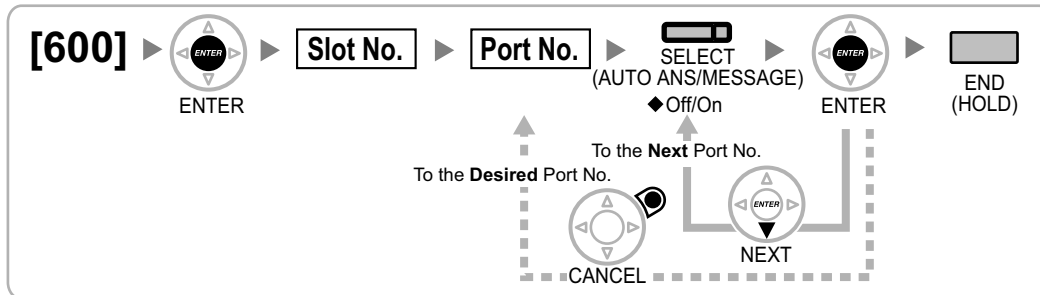

[601] Terminal Device Assignment

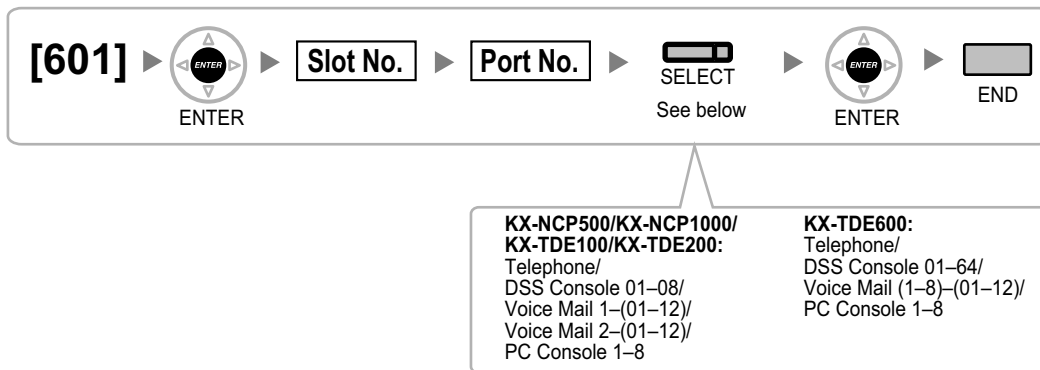

Note

When changing the type of a port for which one or more SDN buttons are set (except when changing between PC Console and Telephone), all SDN buttons customized for that device will be deleted.

[602] Class of Service



[603] Extension User Group

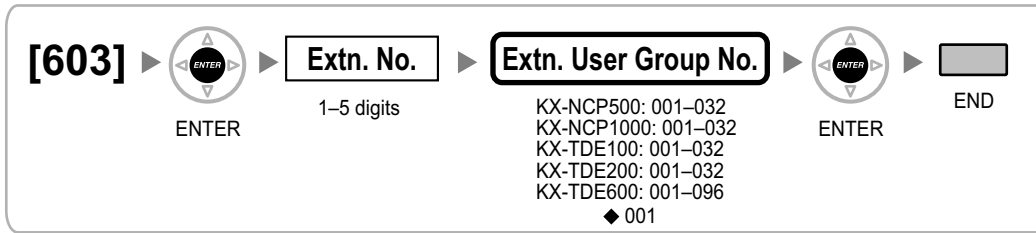

[604] Extension Intercept Destination

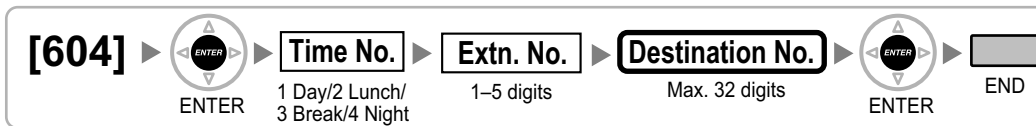

[605] Call Forwarding—No Answer Time

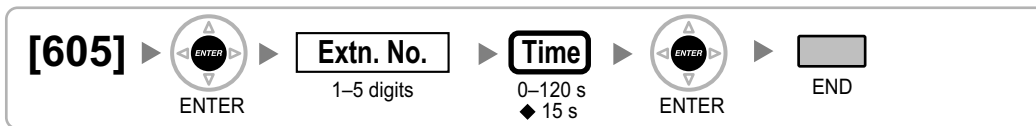

[606] CLIP Number



[620] Incoming Call Distribution Group Member

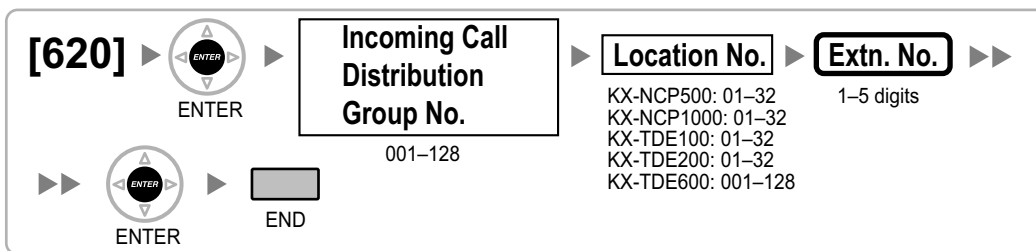

[621] Incoming Call Distribution Group Delayed Ringing

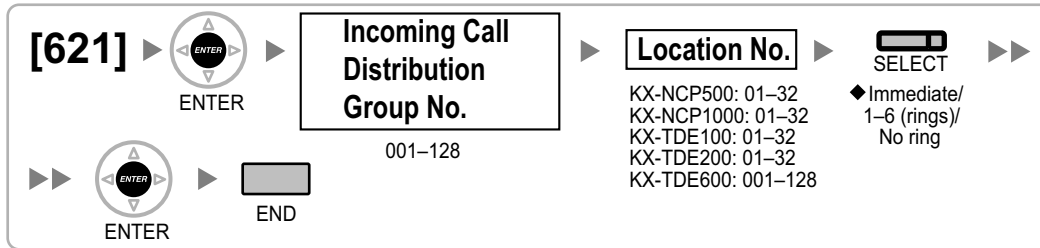

[622] Incoming Call Distribution Group Floating Extension Number

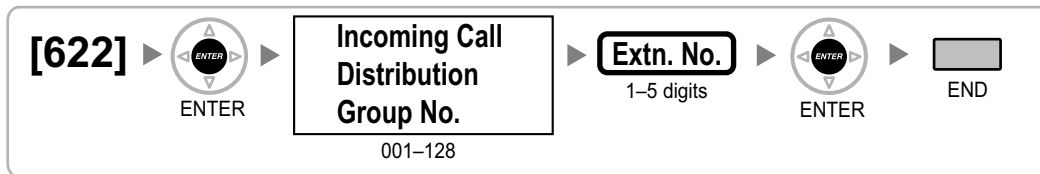

[623] Incoming Call Distribution Group Name

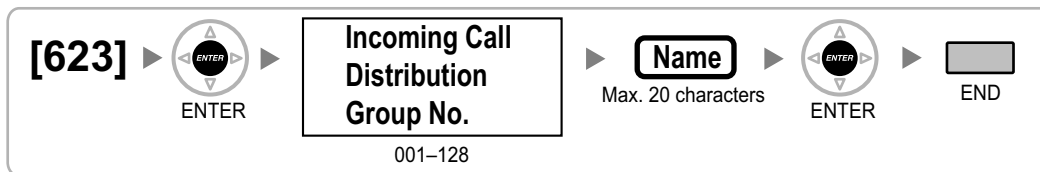

[624] Incoming Call Distribution Group Distribution Method

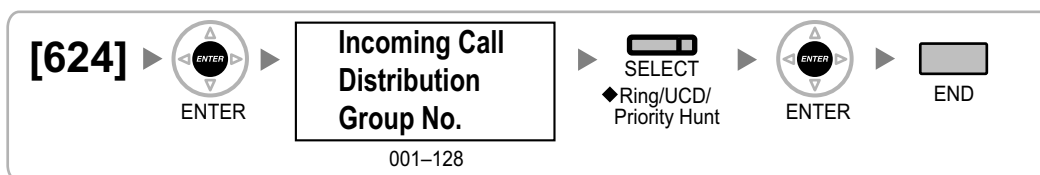

[625] Destination for Overflow Time Expiration

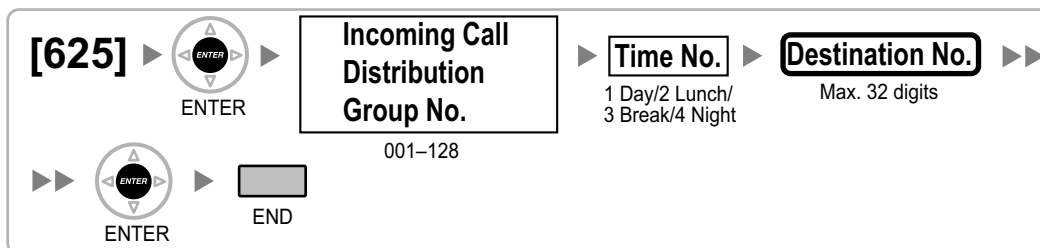

[626] Overflow Time

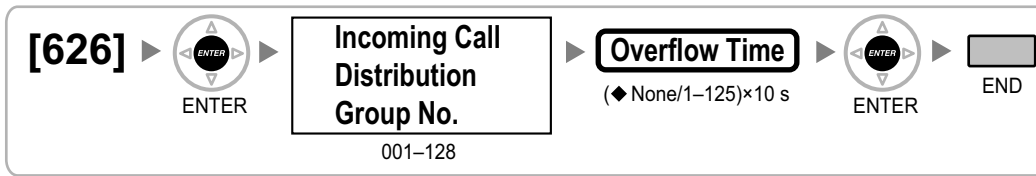

[627] Destination When All Busy

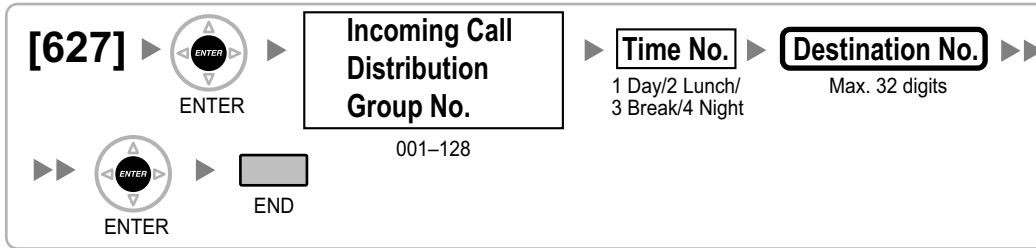

[628] Queuing Call Capacity

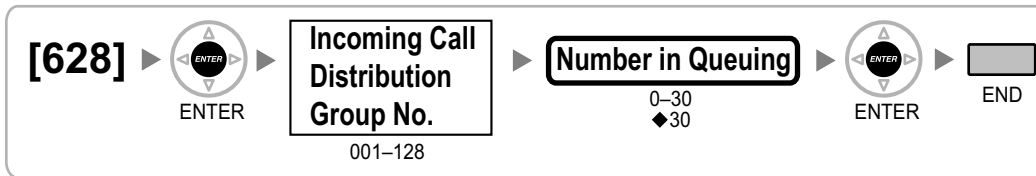

[629] Queuing Hurry-up Level



[630] Queuing Time Table

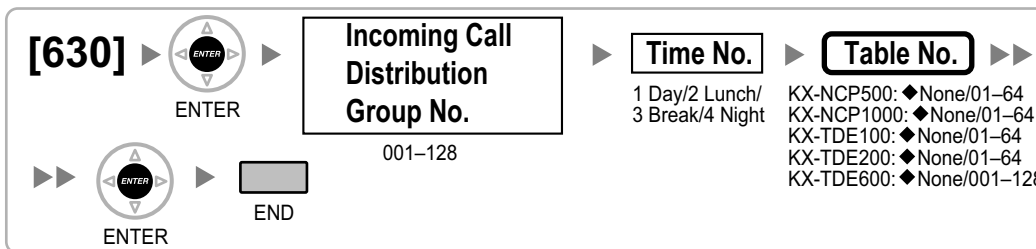

[631] Sequences in Queuing Time Table

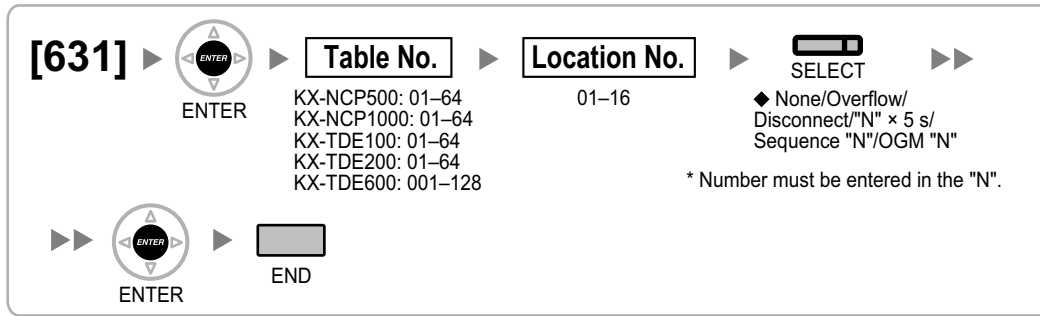

[632] Maximum Number of Agents

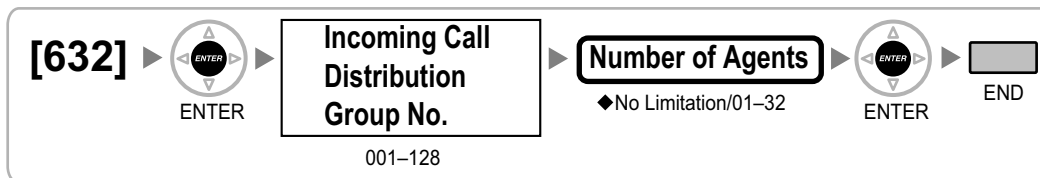

[640] Extension User Groups of a Paging Group

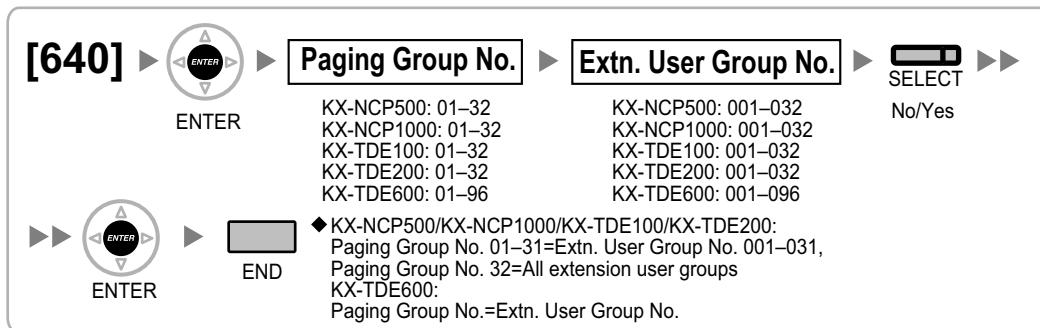

[641] External Pagers of a Paging Group

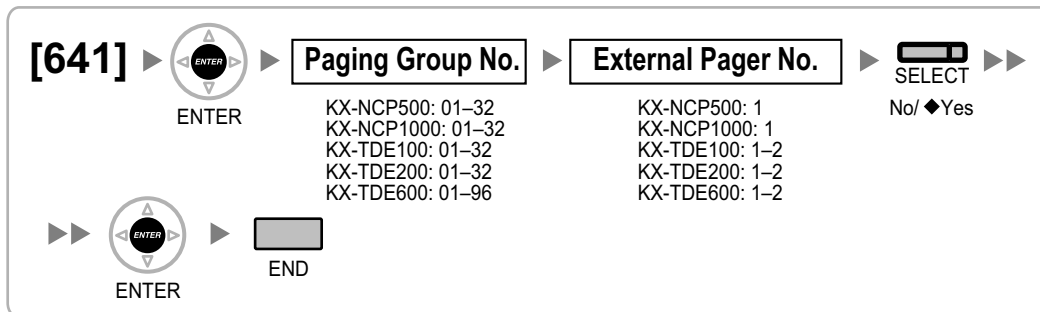

[650] Extension User Groups of a Pickup Group

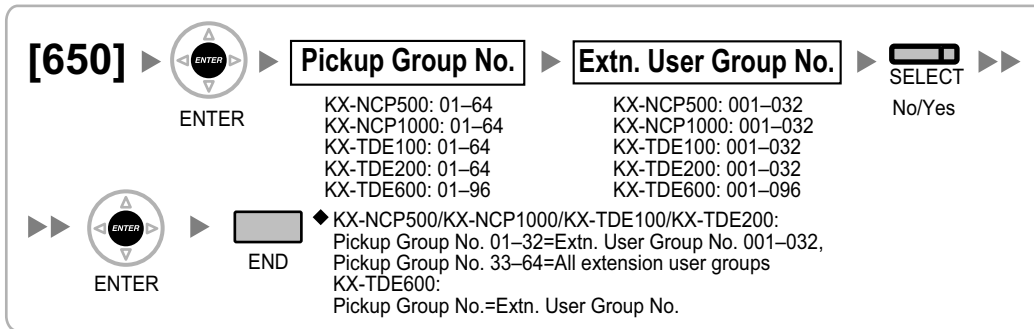

[660] VM Group Floating Extension Number

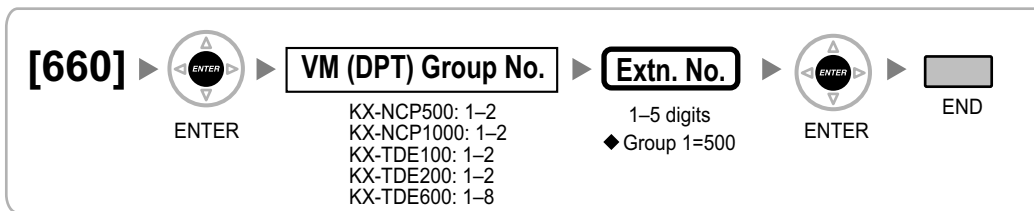

[680] Idle Extension Hunting Type

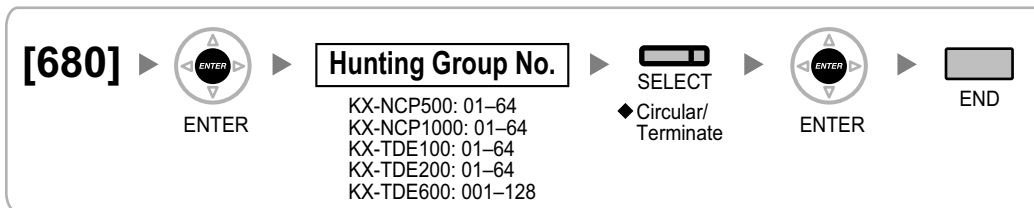

[681] Idle Extension Hunting Group Member

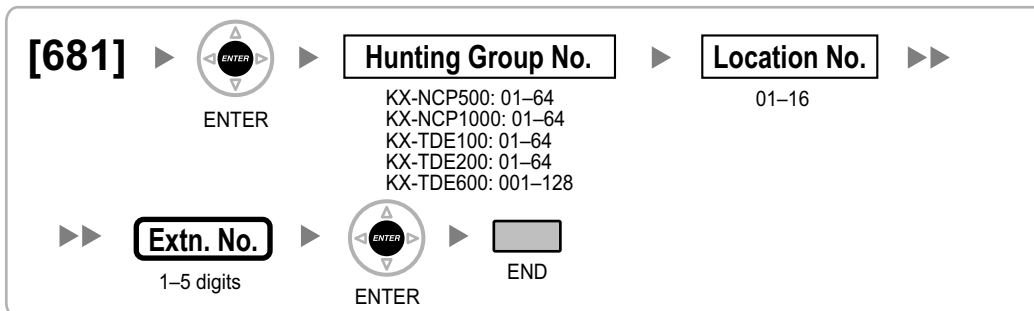

[690] PS Registration

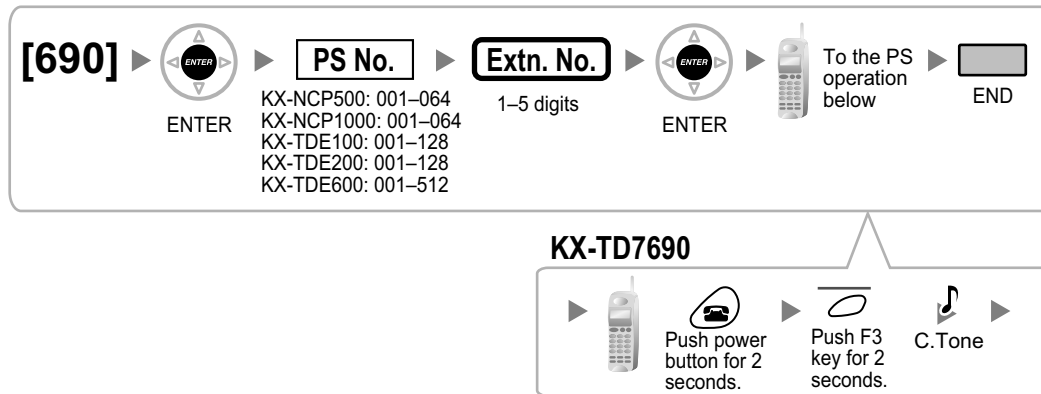

Note

For details about PS registration, refer to the Quick Installation Guide for the relevant Cell Station (CS).

[691] PS Termination

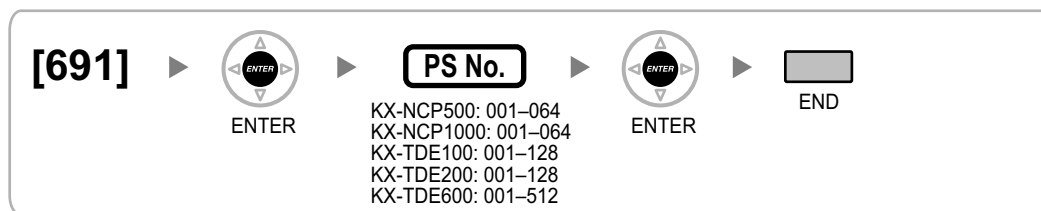

[692] Personal Identification Number (PIN) for PS Registration

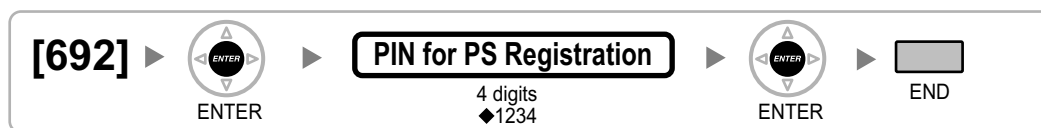

[699] CS Status Reference



2.1.10 Resource/Interface Programming

[700] External Pager Floating Extension Number

[KX-NCP500/KX-NCP1000]



[KX-TDE100/KX-TDE200/KX-TDE600]

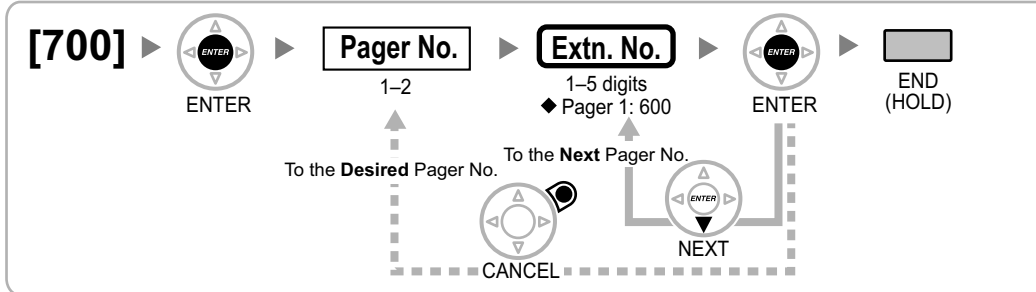

[710] Music Source Selection for BGM (for KX-NCP500/KX-NCP1000)/BGM2 (for KX-TDE100/KX-TDE200/KX-TDE600)



[711] Music on Hold

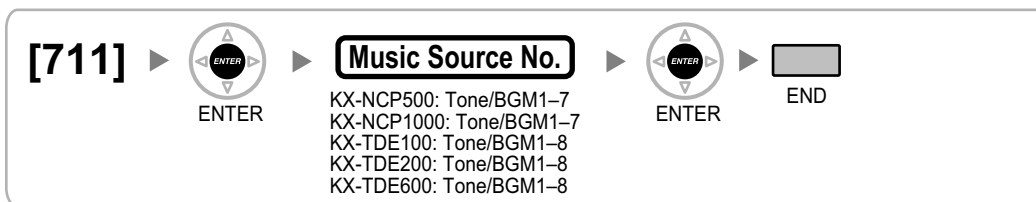

[712] Music for Transfer

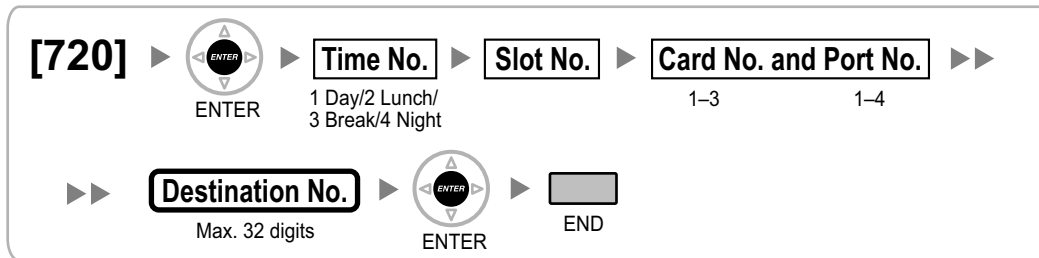
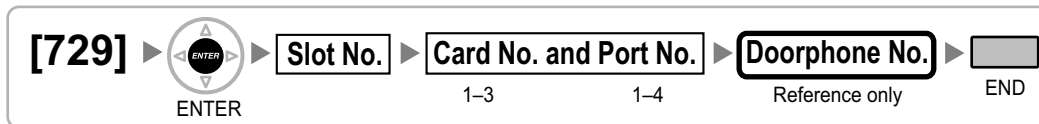
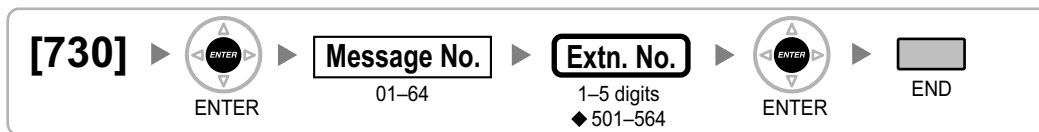
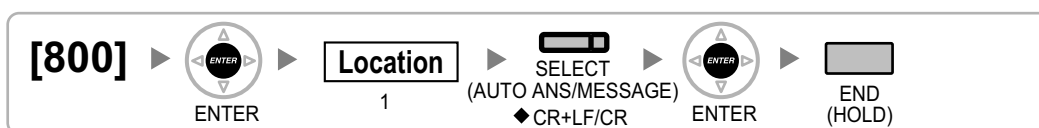

[720] Doorphone Call Destination**[729] Doorphone Number Reference****[730] Outgoing Message (OGM) Floating Extension Number****[731] Outgoing Message (OGM) Name****[732] DISA Security Mode****2.1.11 SMDR & Maintenance Programming****[800] RS-232C Parameter—New Line Code**

[800] RS-232C Parameter—Baud Rate

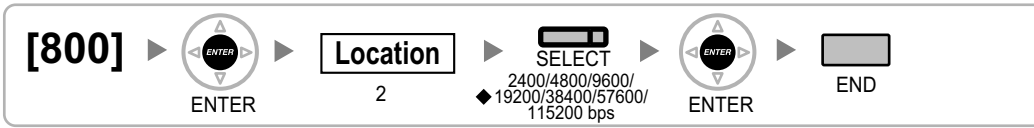

[800] RS-232C Parameter—Word Length



[800] RS-232C Parameter—Parity Bit

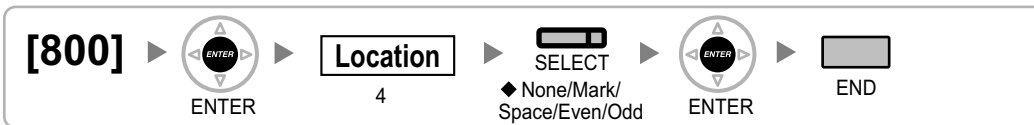

[800] RS-232C Parameter—Stop Bit Length

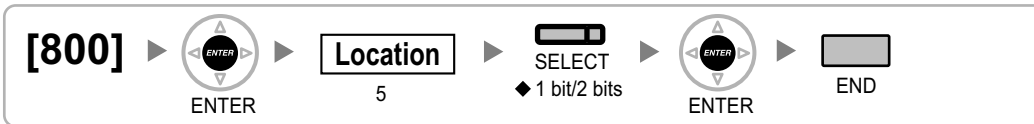

[801] External Modem Control

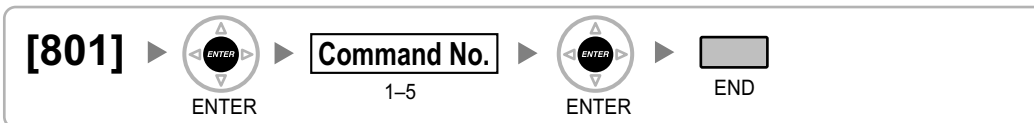

[802] SMDR Page Length



[803] SMDR Skip Perforation

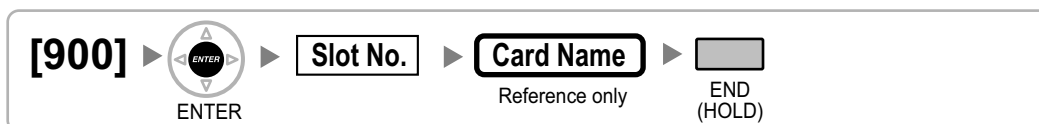

[804] SMDR Outgoing Call Printing**[805] SMDR Incoming Call Printing****[810] Remote Programming****[811] Modem Floating Extension Number****[812] ISDN Remote Floating Extension Number****2.1.12 Card Programming****[900] Slot Card Type Reference**

[901] Slot Card Deletion

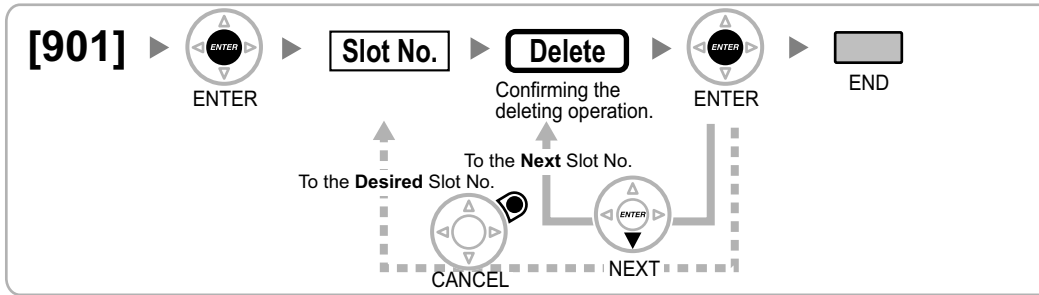

[902] Slot Card Reset

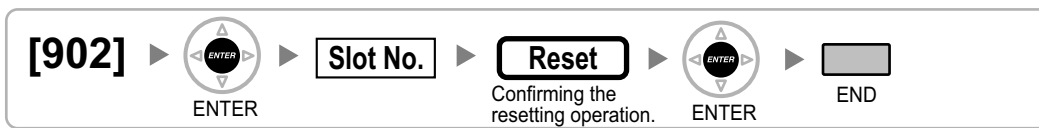

[910] OPB3 Option Card Type Reference



[911] OPB3 Option Card Deletion

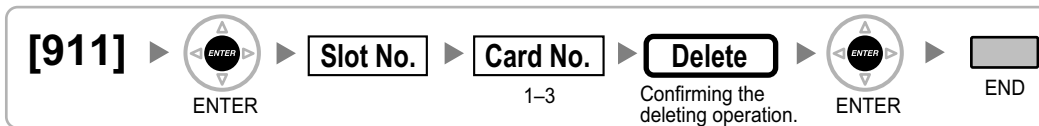

Section 3

Appendix

3.1 Revision History

3.1.1 KX-NCP500/KX-NCP1000 PBMPR Software File Version 2.02xx

Changed Contents

- 2.1.9 Extension Programming
[690] PS Registration
- 2.1.10 Resource/Interface Programming
[711] Music on Hold

3.1.2 KX-NCP500/KX-NCP1000 PBMPR Software File Version 6.0xxx

New Contents

- 2.1.6 TRS/ARS Programming
[347] ARS Routing Plan Table (1–48)

Changed Contents

- 2.1.6 TRS/ARS Programming
[322] ARS Routing Plan Table Number
[330] ARS Routing Plan Time Table
[331–346] ARS Routing Plan Table (1–16) (KX-NCP500/KX-NCP1000/KX-TDE100/KX-TDE200 only)
[350] ARS Carrier Name
[351] ARS Trunk Group for Carrier Access
[352] ARS Removed Number of Digits for Carrier Access
[353] ARS Carrier Access Code

3.1.3 KX-NCP500/KX-NCP1000 PBMPR Software File Version 7.xxxx

Changed Contents

- 1.1.3 Entering Characters
- 2.1.1 Programming Instructions

3.1.4 KX-TDE100/KX-TDE200 PMMPR Software File Version 3.0xxx

Changed Contents

- 2.1.9 Extension Programming
[690] PS Registration

- 2.1.10 Resource/Interface Programming
[710] Music Source Selection for BGM (for KX-NCP500/KX-NCP1000)/BGM2 (for KX-TDE100/
KX-TDE200/KX-TDE600)
[711] Music on Hold

3.1.5 KX-TDE100/KX-TDE200 PMMPR Software File Version 6.0xxx

New Contents

- 2.1.6 TRS/ARS Programming
[347] ARS Routing Plan Table (1–48)

Changed Contents

- 2.1.6 TRS/ARS Programming
[322] ARS Routing Plan Table Number
[330] ARS Routing Plan Time Table
[331–346] ARS Routing Plan Table (1–16) (KX-NCP500/KX-NCP1000/KX-TDE100/KX-TDE200 only)
[350] ARS Carrier Name
[351] ARS Trunk Group for Carrier Access
[352] ARS Removed Number of Digits for Carrier Access
[353] ARS Carrier Access Code

3.1.6 KX-TDE100/KX-TDE200 PMMPR Software File Version 7.xxxx

Changed Contents

- 1.1.3 Entering Characters
- 2.1.1 Programming Instructions

3.1.7 KX-TDE600 PGMPR Software File Version 3.0xxx

Changed Contents

- 2.1.9 Extension Programming
[690] PS Registration
- 2.1.10 Resource/Interface Programming
[710] Music Source Selection for BGM (for KX-NCP500/KX-NCP1000)/BGM2 (for KX-TDE100/
KX-TDE200/KX-TDE600)
[711] Music on Hold

3.1.8 KX-TDE600 PGMPR Software File Version 6.0xxx

Changed Contents

- 2.1.6 TRS/ARS Programming
[322] ARS Routing Plan Table Number

[330] ARS Routing Plan Time Table
[331–346] ARS Routing Plan Table (1–16) (KX-NCP500/KX-NCP1000/KX-TDE100/KX-TDE200 only)
[350] ARS Carrier Name
[351] ARS Trunk Group for Carrier Access
[352] ARS Removed Number of Digits for Carrier Access
[353] ARS Carrier Access Code

3.1.9 KX-TDE600 PGMPR Software File Version 7.xxxx

Changed Contents

- 1.1.3 Entering Characters
- 2.1.1 Programming Instructions

3.2 Feature Programming References

Absent Message

- [008] Absent Message

Feature Manual References

1.1.1 Absent Message

Account Code Entry

- [508] Account Code Mode

Feature Manual References

1.1.2 Account Code Entry

ARS (Automatic Route Selection)

- [320] ARS Mode
- [321] ARS Leading Number
- [322] ARS Routing Plan Table Number
- [325] ARS Exception Number
- [330] ARS Routing Plan Time Table
- [331–346] ARS Routing Plan Table (1–16) (KX-NCP500/KX-NCP1000/KX-TDE100/KX-TDE200 only)
- [347] ARS Routing Plan Table (1–48)
- [350] ARS Carrier Name
- [351] ARS Trunk Group for Carrier Access
- [352] ARS Removed Number of Digits for Carrier Access
- [353] ARS Carrier Access Code

Feature Manual References

1.1.3 ARS (Automatic Route Selection)

Call Hold

- [200] Hold Recall Time

Feature Manual References

3.1.5 Call Hold

Call Pickup

- [650] Extension User Groups of a Pickup Group

Feature Manual References

3.1.9 Call Pickup

Call Transfer

- [201] Transfer Recall Time
- [503] Call Transfer to CO Line
- [712] Music for Transfer

Feature Manual References

3.1.11 Call Transfer

Caller ID

- [001] System Speed Dialing Number
- [002] System Speed Dialing Name
- [490] Caller ID Signal Type

Feature Manual References

3.1.3 Caller ID

CLI (Calling Line Identification) Distribution

- [001] System Speed Dialing Number
- [002] System Speed Dialing Name

Feature Manual References

3.1.15 CLI (Calling Line Identification) Distribution

CLIP (Calling Line Identification Presentation)

- [003] Extension Number
- [606] CLIP Number

Feature Manual References

3.1.16 CLIP (Calling Line Identification Presentation)

COS (Class of Service)

- 2.1.8 COS Programming
- [602] Class of Service

Feature Manual References

3.1.23 COS (Class of Service)

CPC (Calling Party Control) Signal Detection

- [413] LCOT CPC Signal Detection Time—Outgoing
- [414] LCOT CPC Signal Detection Time—Incoming

Feature Manual References

3.1.24 CPC (Calling Party Control) Signal Detection

CO Line Access

- [400] LCOT CO Line Connection
- [401] LCOT CO Line Name
- [409] LCOT CO Line Number Reference
- [500] Trunk Group Number

Feature Manual References

3.1.17 CO Line Access

CO Line Call Limitation

- [472] Extension-to-CO Line Call Duration
- [473] CO-to-CO Line Call Duration
- [502] CO Line Call Duration Limitation

Feature Manual References

3.1.18 CO Line Call Limitation

Dial Mode Selection

- [410] LCOT Dialing Mode
- [411] LCOT Pulse Rate
- [412] LCOT DTMF Minimum Duration

Feature Manual References

4.1.3 Dial Mode Selection

DID (Direct Inward Dialing)

- [451] DID Number
- [452] DID Name
- [453] DID Destination

Feature Manual References

4.1.6 DID (Direct Inward Dialing)

DIL (Direct In Line)

- [450] DIL 1:1 Destination

Feature Manual References

4.1.7 DIL (Direct In Line)

DISA (Direct Inward System Access)

- [209] DISA Delayed Answer Time
- [210] DISA CO-to-CO Line Call Prolong Time
- [211] DISA Intercept Time
- [475] DISA Silence Detection
- [476] DISA Continuous Signal Detection
- [477] DISA Cyclic Signal Detection
- [604] Extension Intercept Destination
- [730] Outgoing Message (OGM) Floating Extension Number
- [731] Outgoing Message (OGM) Name
- [732] DISA Security Mode

Feature Manual References

4.1.8 DISA (Direct Inward System Access)

DND (Do Not Disturb)

- [507] DND Override

Feature Manual References

4.1.10 DND (Do Not Disturb)

Door Open

- [207] Door Unlock Time
- [512] Permission for Door Open Access

Feature Manual References

4.1.11 Door Open

Doorphone Call

- [720] Doorphone Call Destination
- [729] Doorphone Number Reference

Feature Manual References

4.1.12 Doorphone Call

EFA (External Feature Access)

- [417] LCOT Flash/Recall Time

Feature Manual References

5.1.1 EFA (External Feature Access)

Emergency Call

- [304] Emergency Number

Feature Manual References

5.1.2 Emergency Call

Executive Busy Override

- [505] Executive Busy Override
- [506] Executive Busy Override Deny

Feature Manual References

5.1.3 Executive Busy Override

Extension Dial Lock

- [510] TRS Level for Extension Dial Lock

Feature Manual References

5.1.4 Extension Dial Lock

Extension PIN (Personal Identification Number)

- [005] Extension Personal Identification Number (PIN)

Feature Manual References

5.1.6 Extension PIN (Personal Identification Number)

Extension Port Configuration

- [007] DSS Console Paired Telephone
- [600] EXtra Device Port (XDP) Mode

Feature Manual References

5.1.7 Extension Port Configuration

Flash/Recall/Terminate

- [418] LCOT Disconnect Time

Feature Manual References

6.1.2 Flash/Recall/Terminate

Flexible Numbering/Fixed Numbering

- [100] Flexible Numbering

Feature Manual References

6.1.4 Flexible Numbering/Fixed Numbering

Floating Extension

- [623] Incoming Call Distribution Group Name
- [660] VM Group Floating Extension Number
- [700] External Pager Floating Extension Number
- [730] Outgoing Message (OGM) Floating Extension Number
- [731] Outgoing Message (OGM) Name
- [811] Modem Floating Extension Number
- [812] ISDN Remote Floating Extension Number

Feature Manual References

6.1.5 Floating Extension

FWD (Call Forwarding)

- [472] Extension-to-CO Line Call Duration
- [473] CO-to-CO Line Call Duration
- [504] Call Forwarding to CO Line
- [605] Call Forwarding—No Answer Time

Feature Manual References

6.1.6 FWD (Call Forwarding)

Host PBX Access Code (Access Code to the Telephone Company from a Host PBX)

- [471] Host PBX Access Code

Feature Manual References

8.1.5 Host PBX Access Code (Access Code to the Telephone Company from a Host PBX)

Hot Line

- [204] Hot Line Waiting Time

Feature Manual References

8.1.6 Hot Line

ICD Group Features

- [620] Incoming Call Distribution Group Member
- [621] Incoming Call Distribution Group Delayed Ringing
- [622] Incoming Call Distribution Group Floating Extension Number
- [623] Incoming Call Distribution Group Name
- [624] Incoming Call Distribution Group Distribution Method
- [625] Destination for Overflow Time Expiration
- [626] Overflow Time
- [627] Destination When All Busy
- [628] Queuing Call Capacity
- [629] Queuing Hurry-up Level
- [630] Queuing Time Table
- [631] Sequences in Queuing Time Table
- [632] Maximum Number of Agents

Feature Manual References

9.1.1 ICD GROUP FEATURES

ICD Group Features—Group Call Distribution

- [621] Incoming Call Distribution Group Delayed Ringing
- [624] Incoming Call Distribution Group Distribution Method
- [632] Maximum Number of Agents

Feature Manual References

9.1.2 ICD Group Features—Group Call Distribution

ICD Group Features—Outside Destinations

- [620] Incoming Call Distribution Group Member
- [621] Incoming Call Distribution Group Delayed Ringing
- [622] Incoming Call Distribution Group Floating Extension Number
- [624] Incoming Call Distribution Group Distribution Method
- [629] Queuing Hurry-up Level

Feature Manual References

9.1.4 ICD Group Features—Outside Destinations

ICD Group Features—Overflow

- [625] Destination for Overflow Time Expiration
- [626] Overflow Time
- [627] Destination When All Busy

- [628] Queuing Call Capacity
- [632] Maximum Number of Agents

Feature Manual References

9.1.5 ICD Group Features—Overflow

ICD Group Features—Queuing

- [628] Queuing Call Capacity
- [629] Queuing Hurry-up Level
- [630] Queuing Time Table
- [631] Sequences in Queuing Time Table
- [632] Maximum Number of Agents

Feature Manual References

9.1.6 ICD Group Features—Queuing

Idle Extension Hunting

- [680] Idle Extension Hunting Type
- [681] Idle Extension Hunting Group Member

Feature Manual References

9.1.9 Idle Extension Hunting

Intercept Routing

- [203] Intercept Time
- [604] Extension Intercept Destination
- [625] Destination for Overflow Time Expiration

Feature Manual References

9.1.11 Intercept Routing

Intercept Routing—No Destination

- [006] Operator Assignment

Feature Manual References

9.1.12 Intercept Routing—No Destination

Intercom Call

- [003] Extension Number
- [004] Extension Name

Feature Manual References

9.1.13 Intercom Call

Line Preference—Outgoing

- [103] Idle Line Access (Local Access)
- [500] Trunk Group Number

Feature Manual References

10.1.3 Line Preference—Outgoing

Manager Features

- [112] Manager Password
- [511] Manager Assignment

Feature Manual References

11.1.1 Manager Features

Music on Hold

- [710] Music Source Selection for BGM (for KX-NCP500/KX-NCP1000)/BGM2 (for KX-TDE100/KX-TDE200/KX-TDE600)
- [711] Music on Hold

Feature Manual References

11.1.4 Music on Hold

OGM (Outgoing Message)

- [631] Sequences in Queuing Time Table
- [730] Outgoing Message (OGM) Floating Extension Number

Feature Manual References

12.1.2 OGM (Outgoing Message)

Operator Features

- [006] Operator Assignment

Feature Manual References

12.1.5 Operator Features

Paging

- [640] Extension User Groups of a Paging Group
- [641] External Pagers of a Paging Group

Feature Manual References

13.1.1 Paging

Paralleled Telephone

- [600] EXtra Device Port (XDP) Mode

Feature Manual References

13.1.2 Paralleled Telephone

Pause Insertion

- [416] LCOT Pause Time

Feature Manual References

13.1.4 Pause Insertion

PC Console/PC Phone

- [601] Terminal Device Assignment

Feature Manual References

13.1.5 PC Console/PC Phone

Private Network Features

- [453] DID Destination
- [500] Trunk Group Number

Feature Manual References

13.1.15 PRIVATE NETWORK FEATURES

Private Network Features—NDSS (Network Direct Station Selection)

- [511] Manager Assignment

Feature Manual References

13.1.17 Private Network Features—NDSS (Network Direct Station Selection)

Private Network Features—PS Roaming by Network ICD Group

- [620] Incoming Call Distribution Group Member
- [622] Incoming Call Distribution Group Floating Extension Number
- [624] Incoming Call Distribution Group Distribution Method

Feature Manual References

13.1.19 Private Network Features—PS Roaming by Network ICD Group

Private Network Features—QSIG—CLIP/COLP (Calling/Connected Line Identification Presentation) and CNIP/CONP (Calling/Connected Name Identification Presentation)

- [003] Extension Number
- [004] Extension Name

Feature Manual References

13.1.23 Private Network Features—QSIG—CLIP/COLP (Calling/Connected Line Identification Presentation) and CNIP/CONP (Calling/Connected Name Identification Presentation)

PS Connection

- [690] PS Registration
- [691] PS Termination
- [692] Personal Identification Number (PIN) for PS Registration

Feature Manual References

13.1.27 PS (Portable Station)

PS Directory

- [001] System Speed Dialing Number
- [002] System Speed Dialing Name
- [004] Extension Name

Feature Manual References

13.1.29 PS—Directory

PS Ring Group

- [620] Incoming Call Distribution Group Member

Feature Manual References

13.1.31 PS—Ring Group

PT Programming

- 2.1 PT Programming
- [516] Programming Mode Limitation

Feature Manual References

13.1.32 PT Programming

Redial, Last Number

- [205] Automatic Redial Repeat Times

Feature Manual References

15.1.1 Redial, Last Number

SMDR (Station Message Detail Recording)

- [800] RS-232C Parameter—New Line Code
- [800] RS-232C Parameter—Baud Rate
- [800] RS-232C Parameter—Word Length
- [800] RS-232C Parameter—Parity Bit
- [800] RS-232C Parameter—Stop Bit Length
- [802] SMDR Page Length
- [803] SMDR Skip Perforation
- [804] SMDR Outgoing Call Printing
- [805] SMDR Incoming Call Printing

Feature Manual References

16.1.4 SMDR (Station Message Detail Recording)

Special Carrier Access Code

- [303] Special Carrier Access Code

Feature Manual References

16.1.6 Special Carrier Access Code

Speed Dialing, System

- [001] System Speed Dialing Number
- [002] System Speed Dialing Name
- [509] TRS Level for System Speed Dialing

Feature Manual References

16.1.8 Speed Dialing, System

TAFAS (Trunk Answer From Any Station)

- [700] External Pager Floating Extension Number

Feature Manual References

17.1.2 TAFAS (Trunk Answer From Any Station)

Tenant Service

- [001] System Speed Dialing Number
- [006] Operator Assignment
- [320] ARS Mode
- [711] Music on Hold

Feature Manual References

17.1.3 Tenant Service

Time Service

- [101] Time Service Switching Mode
- [102] Time Service Starting Time
- [514] Time Service Manual Switching

Feature Manual References

17.1.5 Time Service

TRS (Toll Restriction)

- [300] TRS Override by System Speed Dialing
- [301] TRS Denied Code
- [302] TRS Exception Code
- [501] TRS Level
- [509] TRS Level for System Speed Dialing
- [602] Class of Service

Feature Manual References

17.1.6 TRS (Toll Restriction)

Upgrading the Software

- [190] Main Processing (MPR) Software Version Reference

Feature Manual References

18.1.1 Upgrading the Software

Verification Code Entry

- [120] Verification Code
- [121] Verification Code Name
- [122] Verification Code Personal Identification Number (PIN)
- [123] Verification Code COS Number

Feature Manual References

19.1.1 Verification Code Entry

Virtual PS

- [690] PS Registration

Feature Manual References

19.1.2 Virtual PS

Voice Mail (VM) Group

- [601] Terminal Device Assignment
- [660] VM Group Floating Extension Number

Feature Manual References

19.1.3 Voice Mail (VM) Group

Voice Mail DPT (Digital) Integration

- [201] Transfer Recall Time

Feature Manual References

19.1.4 Voice Mail DPT (Digital) Integration

Walking COS

- [005] Extension Personal Identification Number (PIN)

Feature Manual References

20.1.1 Walking COS

Walking Extension

- [007] DSS Console Paired Telephone

Feature Manual References

20.1.2 Walking Extension

Wireless XDP Parallel Mode

- [515] Wireless XDP Parallel Mode for Paired Telephone

Feature Manual References

20.1.5 Wireless XDP Parallel Mode

Panasonic Corporation of North America

One Panasonic Way, Secaucus, New Jersey 07094

<http://www.panasonic.com/bts>

Copyright:

This material is copyrighted by Panasonic System Networks Co., Ltd., and may be reproduced for internal use only. All other reproduction, in whole or in part, is prohibited without the written consent of Panasonic System Networks Co., Ltd.

© Panasonic System Networks Co., Ltd. 2010